

## 42 V Input Window Voltage Detector

No. EA-405-200904

### OVERVIEW

The R3152N is a window voltage detector suited for achieving the functional safety. This device monitors over- and under- voltage of the output voltage from the power supply IC for a microprocessor and a sensor, and can prevent malfunction of system caused by abnormal voltage.

### KEY BENEFITS

- A stable voltage with supplying the battery voltage can provide the power supply and the voltage supervising separately.
- High-accuracy detection enables with Overvoltage/Undervoltage Detection Accuracy of -1.25% to 0.75% and Hysteresis of 1.5%
- Small package of SOT-23-6 is adopted, and a safe and secure pin assignment with considering a short among adjacent pins.

### KEY SPECIFICATIONS

- Operating Voltage Range (Max. Rating): 3.0 V to 42.0 V (50.0 V)
- Operating Temperature Range: -40°C to 105°C
- Supply Current: Typ. 1.5  $\mu$ A
- Overvoltage Detection: 1.1 V to 5.9 V (0.01 V step)
- Undervoltage Detection: 1.0 V to 4.8 V (0.01 V step)
- Detection Release Hysteresis: A, Typ. 1.0% with hysteresis  
B, No hysteresis
- Detection Voltage Accuracy:  
 $\pm 0.5\%$  ( $T_a = 25^\circ\text{C}$ )  
 $-1.25\%$  to  $0.75\%$  ( $-40^\circ\text{C} \leq T_a \leq 105^\circ\text{C}$ )
- Release Output Delay Time: Typ. 4 ms ( $C_D = 0.01 \mu\text{F}$ )
- Output Type: Nch. Open Drain

### SELECTION GUIDE

Product Name	Package	Quantity per Reel
R3152Nxxx\$-TR-FE	SOT-23-6	3,000 pcs

xxx: The combination of an overvoltage detection setting voltage ( $V_{OVSET}$ ) and an undervoltage detection setting voltage ( $V_{UVSET}$ )

Refer to *Product-specific Electrical Characteristics* for more details.

\$: Hysteresis

\$	Hysteresis
A	Yes
B	No

### TYPICAL APPLICATIONS

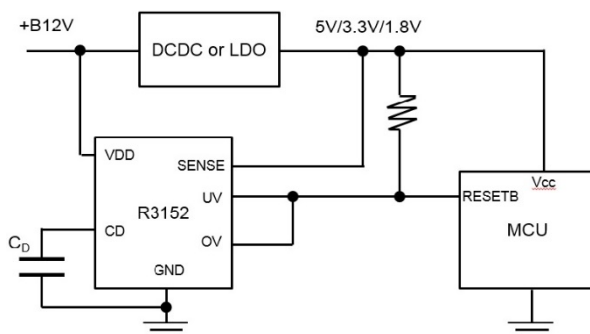

$C_D$ : a capacitor set according to the release delay times

### PACKAGE

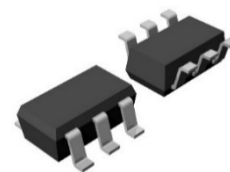

**SOT-23-6**  
2.9 x 2.8 x 1.1 (mm)

### APPLICATIONS

- Power Supply Voltage Monitoring for Laptop PCs, Digital TVs, Cordless Phones and Private LAN Systems
- Power Supply Voltage Monitoring for Multi-cell Battery Using Devices

---

## R3152N

---

No. EA-405-200904

### SELECTION GUIDE

The overvoltage detection setting voltage ( $V_{OVSET}$ ) and the undervoltage detection setting voltage ( $V_{UVSET}$ ) are user-selectable options.

#### Selection Guide

Product Name	Package	Quantity per Reel	Pb Free	Halogen Free
R3152Nxxx\$-TR-FE	SOT-23-6	3,000 pcs	Yes	Yes

xxx: The combination of an overvoltage detection setting voltage ( $V_{OVSET}$ ) and an undervoltage detection setting voltage ( $V_{UVSET}$ ).

Refer to *Product-specific Electrical Characteristics* for more details.

\$: Hysteresis

\$	Hysteresis
A	Yes
B	No

---

### BLOCK DIAGRAM

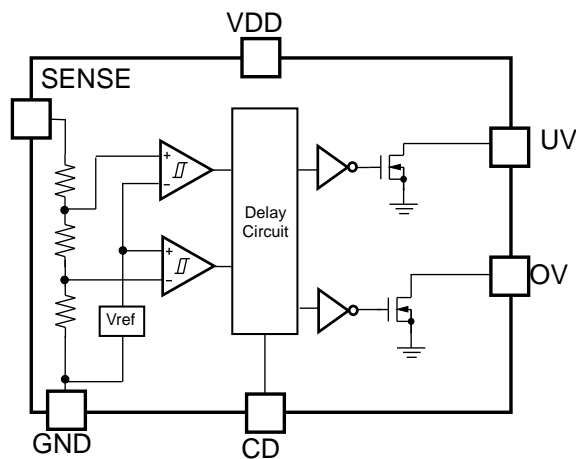

R3152N Block Diagram

## PIN DESCRIPTIONS

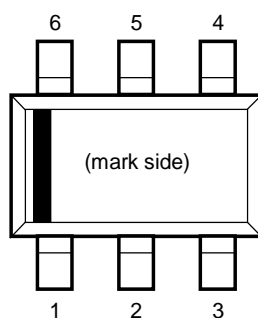

SOT-23-6 Pin Configuration

## Pin Description

Pin No.	Symbol	Description
1	VDD	Supply Voltage Pin
2	CD	VD Release Delay Time Set Pin (for connecting with external capacitor for delay)
3	UV	Undervoltage Detection Output Pin ("Low" at detection)
4	OV	Overvoltage Detection Output Pin ("Low" at detection)
5	GND	GND Pin
6	SENSE	SENSE Pin

## Internal Equivalent Circuit for Each Pin

UV Pin

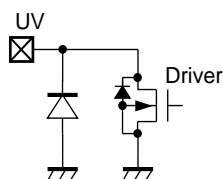

OV Pin

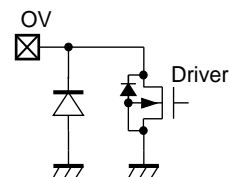

CD Pin

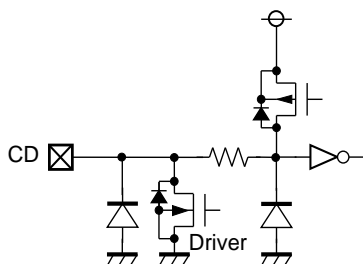

SENSE Pin

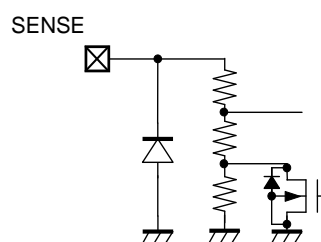

## R3152N

No. EA-405-200904

## ABSOLUTE MAXIMUM RATINGS

### Absolute Maximum Ratings

Symbol	Parameter	Rating	Unit
$V_{DD}$	Supply Voltage	-0.3 to 50.0	V
	Peak Voltage <sup>(1)</sup>	60	V
$V_{CD}$	CD Pin Output Voltage	-0.3 to 50.0	V
$V_{UVOUT}$	UV Pin Output Voltage	-0.3 to 7.0	V
$V_{OVOUT}$	OV Pin Output Voltage	-0.3 to 7.0	V
$V_{SENSE}$	SENSE Pin Input Voltage	-0.3 to 7.0	V
$I_{UVOUT}$	UV Pin Output Current	30	mA
$I_{OVOUT}$	OV Pin Output Current	30	mA
$P_D$	Power Dissipation <sup>(2)</sup> (SOT-23-6, JEDEC STD.51-7)	660	mW
$T_j$	Junction Temperature Range	-40 to 125	°C
$T_{stg}$	Storage Temperature Range	-55 to 125	°C

### ABSOLUTE MAXIMUM RATINGS

Electronic and mechanical stress momentarily exceeded absolute maximum ratings may cause permanent damage and may degrade the life time and safety for both device and system using the device in the field. The functional operation at or over these absolute maximum ratings are not assured.

## RECCOMENDED OPERATING CONDITIONS

### Recommended Operating Conditions

Symbol	Parameter	Rating	Unit
$V_{DD}$	Operating Voltage	3.0 to 42	V
$V_{SENSE}$	SENSE Pin Input Voltage	0 to 6.0	V
$T_a$	Operating Temperature Range	-40 to 105	°C

### RECOMMENDED OPERATING CONDITIONS

All of electronic equipment should be designed that the mounted semiconductor devices operate within the recommended operating conditions. The semiconductor devices cannot operate normally over the recommended operating conditions, even if they are used over such ratings by momentary electronic noise or surge. And the semiconductor devices may receive serious damage when they continue to operate over the recommended operating conditions.

<sup>(1)</sup> Duration Time: 200 ms

<sup>(2)</sup> Refer to *POWER DISSIPATION* for detailed information.

## ELECTRICAL CHARACTERISTICS

$V_{DD} = 14\text{ V}$ ,  $C_D = 0.01\ \mu\text{F}$ , pulled-up to 5 V with 100 k $\Omega$ , unless otherwise specified.

The specifications surrounded by   are guaranteed by design engineering at  $-40^\circ\text{C} \leq T_a \leq 105^\circ\text{C}$ .

### R3152N Electrical Characteristics

( $T_a = 25^\circ\text{C}$ )

Symbol	Parameter	Test Conditions/Comments	Min.	Typ.	Max.	Unit
$V_{OVDET}$	Overvoltage (OV) Detector Threshold	$T_a = 25^\circ\text{C}$	x0.995		x1.005	V
		$-40^\circ\text{C} \leq T_a \leq 105^\circ\text{C}$	<span style="border: 1px solid black; padding: 0 2px;">x0.9875</span>		<span style="border: 1px solid black; padding: 0 2px;">x1.0075</span>	V
$V_{UVDET}$	Undervoltage (UV) Detector Threshold	$T_a = 25^\circ\text{C}$	x0.995		x1.005	V
		$-40^\circ\text{C} \leq T_a \leq 105^\circ\text{C}$	<span style="border: 1px solid black; padding: 0 2px;">x0.9875</span>		<span style="border: 1px solid black; padding: 0 2px;">x1.0075</span>	V
$V_{OVHYS}$	Overvoltage (OV) Threshold Hysteresis	With Hysteresis	$\frac{V_{OVDET}}{\times 0.005}$	$V_{OVDET} \times 0.01$	$\frac{V_{OVDET}}{\times 0.015}$	V
		No Hysteresis	<span style="border: 1px solid black; padding: 0 2px;">0</span>		<span style="border: 1px solid black; padding: 0 2px;">10</span>	mV
$V_{UVHYS}$	Undervoltage (UV) Threshold Hysteresis	With Hysteresis	$\frac{V_{UVDET}}{\times 0.005}$	$V_{UVDET} \times 0.01$	$\frac{V_{UVDET}}{\times 0.015}$	V
		No Hysteresis	<span style="border: 1px solid black; padding: 0 2px;">0</span>		<span style="border: 1px solid black; padding: 0 2px;">10</span>	mV
$I_{SS}$	Consumption Current	$V_{UVDET} < \text{SENSE} < V_{OVDET}$		1.5	<span style="border: 1px solid black; padding: 0 2px;">3.2</span>	$\mu\text{A}$
$R_{SENSE}$	SENSE Pin Resistance		<span style="border: 1px solid black; padding: 0 2px;">7</span>	14	<span style="border: 1px solid black; padding: 0 2px;">28</span>	M $\Omega$
$V_{UVLO}$	UVLO Detector Threshold			1.8	<span style="border: 1px solid black; padding: 0 2px;">2.8</span>	V
$V_{UVLOHYS}$	UVLO Threshold Hysteresis			0.1	<span style="border: 1px solid black; padding: 0 2px;">0.2</span>	V
$V_{OVOUT}$	Overvoltage (OV) pulled-up output voltage				<span style="border: 1px solid black; padding: 0 2px;">6.0</span>	V
$V_{UVOUT}$	Undervoltage (UV) pulled-up output voltage				<span style="border: 1px solid black; padding: 0 2px;">6.0</span>	V
$V_{DDL OV}$	Overvoltage (OV) Low-operating Voltage <sup>(1)</sup>				<span style="border: 1px solid black; padding: 0 2px;">1.7</span>	V
$V_{DDL UV}$	Undervoltage (UV) Low-operating Voltage <sup>(1)</sup>				<span style="border: 1px solid black; padding: 0 2px;">1.7</span>	V
$I_{OUT}$	OV Pin Nch. Driver Output Current	$V_{DD} = 3.0\text{ V}$ , $V_{DS} = 0.1\text{ V}$	<span style="border: 1px solid black; padding: 0 2px;">0.8</span>	1.8		mA
	UV Pin Nch. Driver Output Current	$V_{DD} = 3.0\text{ V}$ , $V_{DS} = 0.1\text{ V}$	<span style="border: 1px solid black; padding: 0 2px;">0.8</span>	1.8		mA
$I_{LEAK}$	OV Pin Nch. Driver Leak Current	$V_{OVOUT} = 5.5\text{ V}$			<span style="border: 1px solid black; padding: 0 2px;">0.3</span>	$\mu\text{A}$
	UV Pin Nch Driver Leak Current	$V_{UVOUT} = 5.5\text{ V}$			<span style="border: 1px solid black; padding: 0 2px;">0.3</span>	$\mu\text{A}$
$t_{DELAY}$	Release Delay Time		<span style="border: 1px solid black; padding: 0 2px;">2.5</span>	4	<span style="border: 1px solid black; padding: 0 2px;">8</span>	ms

All test items listed under Electrical Characteristics are done under the pulse load condition ( $T_j \approx T_a = 25^\circ\text{C}$ ).

<sup>(1)</sup> Minimum value of power supply voltage when an output voltage will become less than 0.1V at detection.  
(pulled-up resistance: 100 k $\Omega$ , pulled-up voltage: 5 V)

---

**R3152N**

---

No. EA-405-200904

 $V_{DD} = 14\text{ V}$ ,  $C_D = 0.01\text{ }\mu\text{F}$ , pulled-up to 5 V with 100 k $\Omega$ , unless otherwise specified.The specifications surrounded by   are guaranteed by design engineering at  $-40^\circ\text{C} \leq T_a \leq 105^\circ\text{C}$ .**R3152N Product-specific Electrical Characteristics**

(Ta = 25°C)

Product name	V <sub>OVDET</sub> (V)			V <sub>UVDET</sub> (V)			V <sub>OVHYS</sub> (V)			V <sub>UVHYS</sub> (V)		
	Min.	Typ.	Max.	Min.	Typ.	Max.	Min.	Typ.	Max.	Min.	Typ.	Max.
R3152N001A	5.27350	5.30	5.32650	4.67650	4.70	4.72350	<span style="border: 1px solid black; padding: 0 2px;">0.02650</span>	0.05300	<span style="border: 1px solid black; padding: 0 2px;">0.07950</span>	<span style="border: 1px solid black; padding: 0 2px;">0.02350</span>	0.04700	<span style="border: 1px solid black; padding: 0 2px;">0.07050</span>
R3152N002A	3.52230	3.54	3.55770	3.03475	3.05	3.06525	<span style="border: 1px solid black; padding: 0 2px;">0.01770</span>	0.03540	<span style="border: 1px solid black; padding: 0 2px;">0.05310</span>	<span style="border: 1px solid black; padding: 0 2px;">0.01525</span>	0.03050	<span style="border: 1px solid black; padding: 0 2px;">0.04575</span>
R3152N003B	3.55215	3.57	3.58785	2.48750	2.50	2.51250	<span style="border: 1px solid black; padding: 0 2px;">0</span>	-	<span style="border: 1px solid black; padding: 0 2px;">0.01000</span>	<span style="border: 1px solid black; padding: 0 2px;">0</span>	-	<span style="border: 1px solid black; padding: 0 2px;">0.01000</span>
R3152N004A	1.86065	1.87	1.87935	1.73130	1.74	1.74870	<span style="border: 1px solid black; padding: 0 2px;">0.00935</span>	0.01870	<span style="border: 1px solid black; padding: 0 2px;">0.02805</span>	<span style="border: 1px solid black; padding: 0 2px;">0.00870</span>	0.01740	<span style="border: 1px solid black; padding: 0 2px;">0.02610</span>
R3152N005A	3.41285	3.43	3.44715	3.17405	3.19	3.20595	<span style="border: 1px solid black; padding: 0 2px;">0.01715</span>	0.03430	<span style="border: 1px solid black; padding: 0 2px;">0.05145</span>	<span style="border: 1px solid black; padding: 0 2px;">0.01595</span>	0.03190	<span style="border: 1px solid black; padding: 0 2px;">0.04785</span>
R3152N013A	1.32335	1.33	1.33665	1.16415	1.17	1.17585	<span style="border: 1px solid black; padding: 0 2px;">0.00665</span>	0.01330	<span style="border: 1px solid black; padding: 0 2px;">0.01995</span>	<span style="border: 1px solid black; padding: 0 2px;">0.00585</span>	0.01170	<span style="border: 1px solid black; padding: 0 2px;">0.01755</span>
R3152N014A	1.16415	1.17	1.17585	1.06963	1.075	1.08037	<span style="border: 1px solid black; padding: 0 2px;">0.00585</span>	0.01170	<span style="border: 1px solid black; padding: 0 2px;">0.01755</span>	<span style="border: 1px solid black; padding: 0 2px;">0.00538</span>	0.01075	<span style="border: 1px solid black; padding: 0 2px;">0.01613</span>
R3152N015A	1.28355	1.29	1.29645	1.15420	1.16	1.16580	<span style="border: 1px solid black; padding: 0 2px;">0.00645</span>	0.01290	<span style="border: 1px solid black; padding: 0 2px;">0.01935</span>	<span style="border: 1px solid black; padding: 0 2px;">0.00580</span>	0.01160	<span style="border: 1px solid black; padding: 0 2px;">0.01740</span>
R3152N017A	3.55215	3.57	3.58785	2.72630	2.74	2.75370	<span style="border: 1px solid black; padding: 0 2px;">0.01785</span>	0.03570	<span style="border: 1px solid black; padding: 0 2px;">0.05355</span>	<span style="border: 1px solid black; padding: 0 2px;">0.01370</span>	0.02740	<span style="border: 1px solid black; padding: 0 2px;">0.04110</span>
R3152N020A	1.24375	1.25	1.25625	1.11440	1.12	1.12560	<span style="border: 1px solid black; padding: 0 2px;">0.00625</span>	0.01250	<span style="border: 1px solid black; padding: 0 2px;">0.01875</span>	<span style="border: 1px solid black; padding: 0 2px;">0.00560</span>	0.01120	<span style="border: 1px solid black; padding: 0 2px;">0.01680</span>
R3152N201B	1.23380	1.24	1.24620	1.16415	1.17	1.17585	<span style="border: 1px solid black; padding: 0 2px;">0</span>	-	<span style="border: 1px solid black; padding: 0 2px;">0.01000</span>	<span style="border: 1px solid black; padding: 0 2px;">0</span>	-	<span style="border: 1px solid black; padding: 0 2px;">0.01000</span>
R3152N101B	2.58700	2.60	2.61300	2.39795	2.41	2.42205	<span style="border: 1px solid black; padding: 0 2px;">0</span>	-	<span style="border: 1px solid black; padding: 0 2px;">0.01000</span>	<span style="border: 1px solid black; padding: 0 2px;">0</span>	-	<span style="border: 1px solid black; padding: 0 2px;">0.01000</span>
R3152N102B	3.41285	3.43	3.44715	3.16410	3.18	3.19590	<span style="border: 1px solid black; padding: 0 2px;">0</span>	-	<span style="border: 1px solid black; padding: 0 2px;">0.01000</span>	<span style="border: 1px solid black; padding: 0 2px;">0</span>	-	<span style="border: 1px solid black; padding: 0 2px;">0.01000</span>
R3152N203A	1.39300	1.40	1.40700	0.99500	1.00	1.00500	<span style="border: 1px solid black; padding: 0 2px;">0.00700</span>	0.01400	<span style="border: 1px solid black; padding: 0 2px;">0.02100</span>	<span style="border: 1px solid black; padding: 0 2px;">0.00500</span>	0.01000	<span style="border: 1px solid black; padding: 0 2px;">0.01500</span>
R3152N204A	1.62185	1.63	1.63815	1.40295	1.41	1.41705	<span style="border: 1px solid black; padding: 0 2px;">0.00815</span>	0.01630	<span style="border: 1px solid black; padding: 0 2px;">0.02445</span>	<span style="border: 1px solid black; padding: 0 2px;">0.00705</span>	0.01410	<span style="border: 1px solid black; padding: 0 2px;">0.02115</span>
R3152N103A	5.77100	5.80	5.82900	4.75610	4.78	4.80390	<span style="border: 1px solid black; padding: 0 2px;">0.02900</span>	0.05800	<span style="border: 1px solid black; padding: 0 2px;">0.08700</span>	<span style="border: 1px solid black; padding: 0 2px;">0.02390</span>	0.04780	<span style="border: 1px solid black; padding: 0 2px;">0.07170</span>
R3152N104A	3.38300	3.40	3.41700	1.59200	1.60	1.60800	<span style="border: 1px solid black; padding: 0 2px;">0.01700</span>	0.03400	<span style="border: 1px solid black; padding: 0 2px;">0.05100</span>	<span style="border: 1px solid black; padding: 0 2px;">0.00800</span>	0.01600	<span style="border: 1px solid black; padding: 0 2px;">0.02400</span>

$V_{DD} = 14\text{ V}$ ,  $C_D = 0.01\ \mu\text{F}$ , pulled-up to 5 V with 100 k $\Omega$ , unless otherwise specified.

The specifications surrounded by   are guaranteed by design engineering at  $-40^\circ\text{C} \leq T_a \leq 105^\circ\text{C}$ .

## R3152N Product-specific Electrical Characteristics

(-40°C ≤ Ta ≤ 105°C)

Product name	V <sub>OVDET</sub> (V)			V <sub>UVDET</sub> (V)			V <sub>OVHYS</sub> (V)			V <sub>UVHYS</sub> (V)		
	Min.	Typ.	Max.	Min.	Typ.	Max.	Min.	Typ.	Max.	Min.	Typ.	Max.
R3152N001A	<span style="border: 1px solid black; padding: 0 2px;">5.23375</span>	5.30	<span style="border: 1px solid black; padding: 0 2px;">5.33975</span>	<span style="border: 1px solid black; padding: 0 2px;">4.64125</span>	4.70	<span style="border: 1px solid black; padding: 0 2px;">4.73525</span>	<span style="border: 1px solid black; padding: 0 2px;">0.02650</span>	0.0530	<span style="border: 1px solid black; padding: 0 2px;">0.07950</span>	<span style="border: 1px solid black; padding: 0 2px;">0.02350</span>	0.04700	<span style="border: 1px solid black; padding: 0 2px;">0.07050</span>
R3152N002A	<span style="border: 1px solid black; padding: 0 2px;">3.49575</span>	3.54	<span style="border: 1px solid black; padding: 0 2px;">3.56655</span>	<span style="border: 1px solid black; padding: 0 2px;">3.01188</span>	3.05	<span style="border: 1px solid black; padding: 0 2px;">3.07287</span>	<span style="border: 1px solid black; padding: 0 2px;">0.01770</span>	0.0354	<span style="border: 1px solid black; padding: 0 2px;">0.05310</span>	<span style="border: 1px solid black; padding: 0 2px;">0.01525</span>	0.03050	<span style="border: 1px solid black; padding: 0 2px;">0.04575</span>
R3152N003B	<span style="border: 1px solid black; padding: 0 2px;">3.52538</span>	3.57	<span style="border: 1px solid black; padding: 0 2px;">3.59678</span>	<span style="border: 1px solid black; padding: 0 2px;">2.46875</span>	2.50	<span style="border: 1px solid black; padding: 0 2px;">2.51875</span>	<span style="border: 1px solid black; padding: 0 2px;">0</span>	-	<span style="border: 1px solid black; padding: 0 2px;">0.01000</span>	<span style="border: 1px solid black; padding: 0 2px;">0</span>	-	<span style="border: 1px solid black; padding: 0 2px;">0.01000</span>
R3152N004A	<span style="border: 1px solid black; padding: 0 2px;">1.84663</span>	1.87	<span style="border: 1px solid black; padding: 0 2px;">1.88403</span>	<span style="border: 1px solid black; padding: 0 2px;">1.71825</span>	1.74	<span style="border: 1px solid black; padding: 0 2px;">1.75305</span>	<span style="border: 1px solid black; padding: 0 2px;">0.00935</span>	0.01870	<span style="border: 1px solid black; padding: 0 2px;">0.02805</span>	<span style="border: 1px solid black; padding: 0 2px;">0.00870</span>	0.01740	<span style="border: 1px solid black; padding: 0 2px;">0.02610</span>
R3152N005A	<span style="border: 1px solid black; padding: 0 2px;">3.38713</span>	3.43	<span style="border: 1px solid black; padding: 0 2px;">3.45573</span>	<span style="border: 1px solid black; padding: 0 2px;">3.15013</span>	3.19	<span style="border: 1px solid black; padding: 0 2px;">3.21392</span>	<span style="border: 1px solid black; padding: 0 2px;">0.01715</span>	0.03430	<span style="border: 1px solid black; padding: 0 2px;">0.05145</span>	<span style="border: 1px solid black; padding: 0 2px;">0.01595</span>	0.0319	<span style="border: 1px solid black; padding: 0 2px;">0.04785</span>
R3152N013A	<span style="border: 1px solid black; padding: 0 2px;">1.31338</span>	1.33	<span style="border: 1px solid black; padding: 0 2px;">1.33997</span>	<span style="border: 1px solid black; padding: 0 2px;">1.15538</span>	1.17	<span style="border: 1px solid black; padding: 0 2px;">1.17877</span>	<span style="border: 1px solid black; padding: 0 2px;">0.00665</span>	0.01330	<span style="border: 1px solid black; padding: 0 2px;">0.01995</span>	<span style="border: 1px solid black; padding: 0 2px;">0.00585</span>	0.01170	<span style="border: 1px solid black; padding: 0 2px;">0.01755</span>
R3152N014A	<span style="border: 1px solid black; padding: 0 2px;">1.15537</span>	1.17	<span style="border: 1px solid black; padding: 0 2px;">1.17878</span>	<span style="border: 1px solid black; padding: 0 2px;">1.06156</span>	1.075	<span style="border: 1px solid black; padding: 0 2px;">1.08307</span>	<span style="border: 1px solid black; padding: 0 2px;">0.00585</span>	0.01170	<span style="border: 1px solid black; padding: 0 2px;">0.01755</span>	<span style="border: 1px solid black; padding: 0 2px;">0.00538</span>	0.01075	<span style="border: 1px solid black; padding: 0 2px;">0.01613</span>
R3152N015A	<span style="border: 1px solid black; padding: 0 2px;">1.27387</span>	1.29	<span style="border: 1px solid black; padding: 0 2px;">1.29968</span>	<span style="border: 1px solid black; padding: 0 2px;">1.14550</span>	1.16	<span style="border: 1px solid black; padding: 0 2px;">1.16870</span>	<span style="border: 1px solid black; padding: 0 2px;">0.00645</span>	0.01290	<span style="border: 1px solid black; padding: 0 2px;">0.01935</span>	<span style="border: 1px solid black; padding: 0 2px;">0.00580</span>	0.01160	<span style="border: 1px solid black; padding: 0 2px;">0.01740</span>
R3152N017A	<span style="border: 1px solid black; padding: 0 2px;">3.52537</span>	3.57	<span style="border: 1px solid black; padding: 0 2px;">3.59678</span>	<span style="border: 1px solid black; padding: 0 2px;">2.70575</span>	2.74	<span style="border: 1px solid black; padding: 0 2px;">2.76055</span>	<span style="border: 1px solid black; padding: 0 2px;">0.01785</span>	0.03570	<span style="border: 1px solid black; padding: 0 2px;">0.05355</span>	<span style="border: 1px solid black; padding: 0 2px;">0.01370</span>	0.02740	<span style="border: 1px solid black; padding: 0 2px;">0.04110</span>
R3152N020A	<span style="border: 1px solid black; padding: 0 2px;">1.23438</span>	1.25	<span style="border: 1px solid black; padding: 0 2px;">1.25937</span>	<span style="border: 1px solid black; padding: 0 2px;">1.10600</span>	1.12	<span style="border: 1px solid black; padding: 0 2px;">1.12840</span>	<span style="border: 1px solid black; padding: 0 2px;">0.00625</span>	0.01250	<span style="border: 1px solid black; padding: 0 2px;">0.01875</span>	<span style="border: 1px solid black; padding: 0 2px;">0.00560</span>	0.01120	<span style="border: 1px solid black; padding: 0 2px;">0.01680</span>
R3152N201B	<span style="border: 1px solid black; padding: 0 2px;">1.22450</span>	1.24	<span style="border: 1px solid black; padding: 0 2px;">1.24930</span>	<span style="border: 1px solid black; padding: 0 2px;">1.15538</span>	1.17	<span style="border: 1px solid black; padding: 0 2px;">1.17877</span>	<span style="border: 1px solid black; padding: 0 2px;">0</span>	-	<span style="border: 1px solid black; padding: 0 2px;">0.01000</span>	<span style="border: 1px solid black; padding: 0 2px;">0</span>	-	<span style="border: 1px solid black; padding: 0 2px;">0.01000</span>
R3152N101B	<span style="border: 1px solid black; padding: 0 2px;">2.56750</span>	2.60	<span style="border: 1px solid black; padding: 0 2px;">2.61950</span>	<span style="border: 1px solid black; padding: 0 2px;">2.37988</span>	2.41	<span style="border: 1px solid black; padding: 0 2px;">2.42807</span>	<span style="border: 1px solid black; padding: 0 2px;">0</span>	-	<span style="border: 1px solid black; padding: 0 2px;">0.01000</span>	<span style="border: 1px solid black; padding: 0 2px;">0</span>	-	<span style="border: 1px solid black; padding: 0 2px;">0.01000</span>
R3152N102B	<span style="border: 1px solid black; padding: 0 2px;">3.38713</span>	3.43	<span style="border: 1px solid black; padding: 0 2px;">3.45572</span>	<span style="border: 1px solid black; padding: 0 2px;">3.14025</span>	3.18	<span style="border: 1px solid black; padding: 0 2px;">3.20385</span>	<span style="border: 1px solid black; padding: 0 2px;">0</span>	-	<span style="border: 1px solid black; padding: 0 2px;">0.01000</span>	<span style="border: 1px solid black; padding: 0 2px;">0</span>	-	<span style="border: 1px solid black; padding: 0 2px;">0.01000</span>
R3152N203A	<span style="border: 1px solid black; padding: 0 2px;">1.38250</span>	1.40	<span style="border: 1px solid black; padding: 0 2px;">1.41050</span>	<span style="border: 1px solid black; padding: 0 2px;">0.98750</span>	1.00	<span style="border: 1px solid black; padding: 0 2px;">1.00750</span>	<span style="border: 1px solid black; padding: 0 2px;">0.00700</span>	0.01400	<span style="border: 1px solid black; padding: 0 2px;">0.02100</span>	<span style="border: 1px solid black; padding: 0 2px;">0.00500</span>	0.01000	<span style="border: 1px solid black; padding: 0 2px;">0.01500</span>
R3152N204A	<span style="border: 1px solid black; padding: 0 2px;">1.60963</span>	1.63	<span style="border: 1px solid black; padding: 0 2px;">1.64222</span>	<span style="border: 1px solid black; padding: 0 2px;">1.39238</span>	1.41	<span style="border: 1px solid black; padding: 0 2px;">1.42057</span>	<span style="border: 1px solid black; padding: 0 2px;">0.00815</span>	0.01630	<span style="border: 1px solid black; padding: 0 2px;">0.02445</span>	<span style="border: 1px solid black; padding: 0 2px;">0.00705</span>	0.01410	<span style="border: 1px solid black; padding: 0 2px;">0.02115</span>
R3152N103A	<span style="border: 1px solid black; padding: 0 2px;">5.72750</span>	5.80	<span style="border: 1px solid black; padding: 0 2px;">5.84350</span>	<span style="border: 1px solid black; padding: 0 2px;">4.72025</span>	4.78	<span style="border: 1px solid black; padding: 0 2px;">4.81585</span>	<span style="border: 1px solid black; padding: 0 2px;">0.02900</span>	0.05800	<span style="border: 1px solid black; padding: 0 2px;">0.08700</span>	<span style="border: 1px solid black; padding: 0 2px;">0.02390</span>	0.04780	<span style="border: 1px solid black; padding: 0 2px;">0.07170</span>
R3152N104A	<span style="border: 1px solid black; padding: 0 2px;">3.35750</span>	3.40	<span style="border: 1px solid black; padding: 0 2px;">3.42550</span>	<span style="border: 1px solid black; padding: 0 2px;">1.58000</span>	1.60	<span style="border: 1px solid black; padding: 0 2px;">1.61200</span>	<span style="border: 1px solid black; padding: 0 2px;">0.01700</span>	0.03400	<span style="border: 1px solid black; padding: 0 2px;">0.05100</span>	<span style="border: 1px solid black; padding: 0 2px;">0.00800</span>	0.01600	<span style="border: 1px solid black; padding: 0 2px;">0.02400</span>

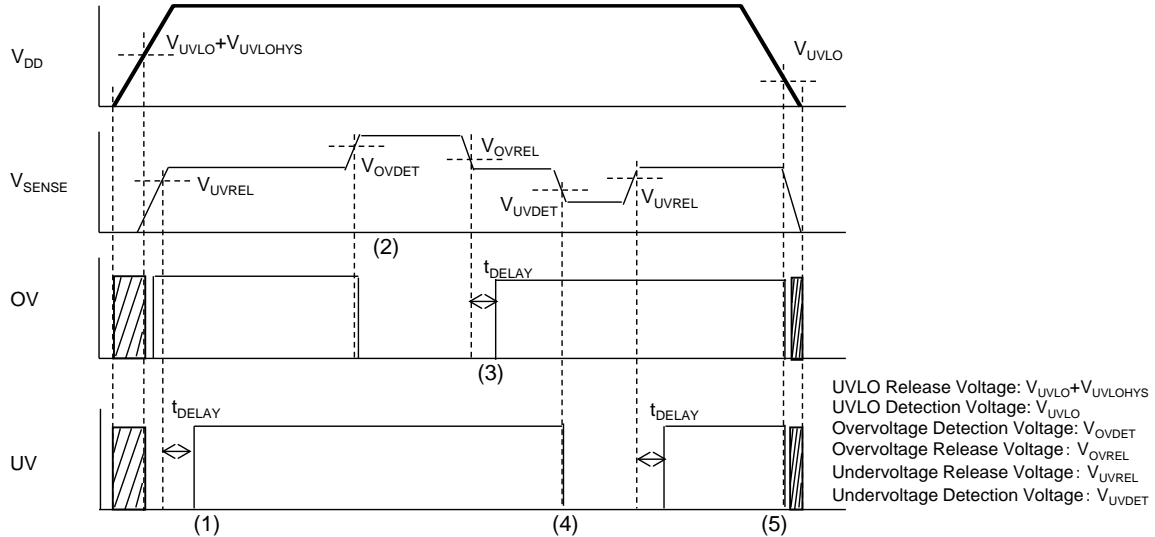
**THEORY OF OPERATION****R3152N Timing Chart**

- (1) When the SENSE pin voltage ( $V_{SENSE}$ ) exceed the undervoltage release voltage ( $V_{UVREL}$ ), the UV pin output becomes “High” after the release delay time ( $t_{DELAY}$ ).
- (2) When  $V_{SENSE}$  exceed the overvoltage detection voltage ( $V_{OVDET}$ ) by increasing in voltage, the OV pin output becomes “Low” after the detection delay time (Typ.10  $\mu$ s) and enters the overvoltage detecting state.
- (3) When  $V_{SENSE}$  decreases less than the overvoltage release voltage ( $V_{OVREL}$ ), the OV pin output becomes “High” after the release delay time ( $t_{DELAY}$ ).
- (4) When  $V_{SENSE}$  decreases less than the undervoltage detection voltage ( $V_{UVDET}$ ), the UV pin output becomes “Low” after the detection delay time (Typ.10  $\mu$ s).
- (5) When the VDD pin voltage ( $V_{DD}$ ) decreases less than the UVLO detection voltage ( $V_{UVLO}$ ), the OV and UV pins output become “Low”.

Note: A certain tilting angle of power supply voltage of the R3152NxxxB may cause chattering at detection or at release. To prevent the occurrence of chattering, connect a 10-nF or more capacitor to the CD pin.



## Delay Operation and Delay Time ( $t_{\text{DELAY}}$ )

### At Undervoltage Detection

When supplying a voltage higher than the undervoltage release voltage ( $V_{\text{UVREL}}$ ) to the SENSE pin, a charging to an external capacitor starts and the CD pin voltage ( $V_{\text{CD}}$ ) increases. The UV pin voltage ( $V_{\text{UV}}$ ) maintains “Low” until  $V_{\text{CD}}$  reaches the CD pin threshold voltage ( $V_{\text{TCD}}$ ). When  $V_{\text{CD}}$  exceeds  $V_{\text{TCD}}$ ,  $V_{\text{UV}}$  is inverted from “Low” to “High”. The release delay time ( $t_{\text{DELAY}}$ ) is the period from the SENSE pin voltage ( $V_{\text{SENSE}}$ ) exceeds  $V_{\text{UVREL}}$  to a rising edge of  $V_{\text{UV}}$ . When the output voltage turns from “Low” to “High”, a charge carrier of the external capacitor starts discharging. When the voltage lower than  $V_{\text{UV}}$  is supplied to the SENSE pin, the detection delay time ( $t_{\text{PHL}}$ ), which is the period that  $V_{\text{UV}}$  is inverted from “High” to “Low”, remains constant independent of the external capacitor.

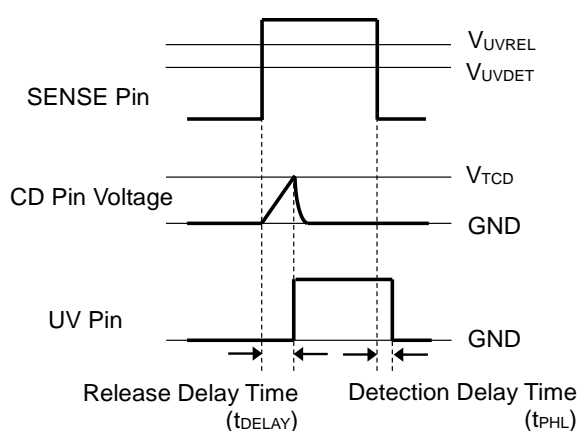

**Undervoltage Release Delay Timing Diagram**

### Calculation of Release Delay Time ( $t_{\text{DELAY}}$ )

The following equation can calculate a typical value of the release delay time ( $t_{\text{DELAY}}$ ) with using the external capacitor ( $C_{\text{D}}$ ).

$$t_{\text{DELAY}} \text{ (s)} = 0.73 \times C_{\text{D}} \text{ (F)} / (1.5 \times 10^{-6})$$

$t_{\text{DELAY}}$  is the period from supplying a pulse voltage of  $1.0 \text{ V} \rightarrow (V_{\text{UVDET}}) + 1.0 \text{ V}$  to the SENSE pin to the UV pins reached  $2.5 \text{ V}$ .

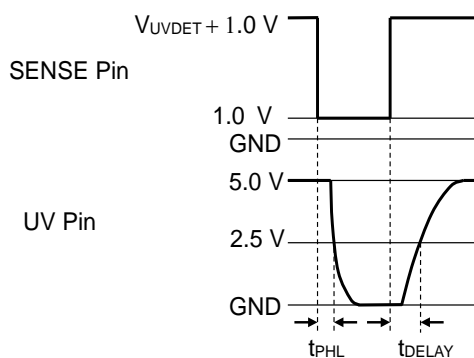

**At Overvoltage Detection**

When supplying a voltage lower than the overvoltage release voltage ( $V_{OVREL}$ ) to the SENSE pin, a charging to an external capacitor starts and the CD pin voltage ( $V_{CD}$ ) increases. The OV pin voltage ( $V_{OV}$ ) maintains “Low” until  $V_{CD}$  reaches the CD pin threshold voltage ( $V_{TCD}$ ). When  $V_{CD}$  exceeds  $V_{TCD}$ ,  $V_{OV}$  is inverted from “Low” to “High”. The release delay time ( $t_{DELAY}$ ) is the period from the SENSE pin voltage ( $V_{SENSE}$ ) falls below  $V_{OVREL}$  to a rising edge of  $V_{OV}$ . When the output voltage turns from “Low” to “High”, a charge carrier of the external capacitor starts discharging. When the voltage higher than  $V_{OV}$  is supplied to the SENSE pin, the detection delay time ( $t_{PHL}$ ), which is the period that  $V_{OV}$  is inverted from “High” to “Low”, remains constant independent of the external capacitor.

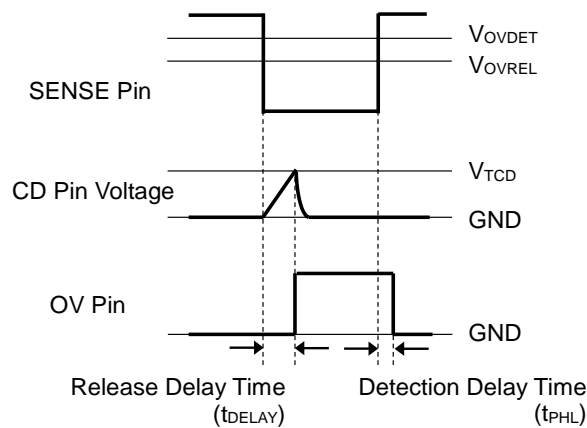

**Overvoltage Release Delay Timing Diagram**

**Calculation of Release Delay Time ( $t_{DELAY}$ )**

The following equation can calculate a typical value of the release delay time ( $t_{DELAY}$ ) with using the external capacitor ( $C_D$ ).

$$t_{DELAY} (s) = 0.73 \times C_D (F) / (1.5 \times 10^{-6})$$

$t_{DELAY}$  is the period from supplying a pulse voltage of  $1.0 V \rightarrow (V_{OVREL}) + 1.0 V$  to the SENSE pin to the OV pin reached 2.5 V after the OV pin is pulled up to 5V by connecting with a resistor of 100kΩ.

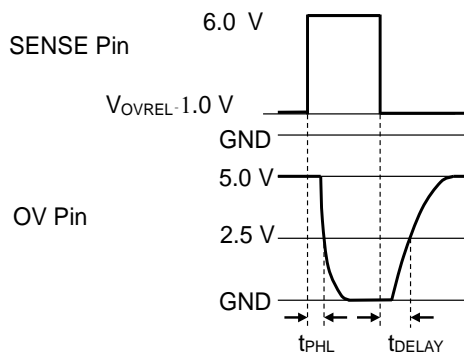

## APPLICATION INFORMATION

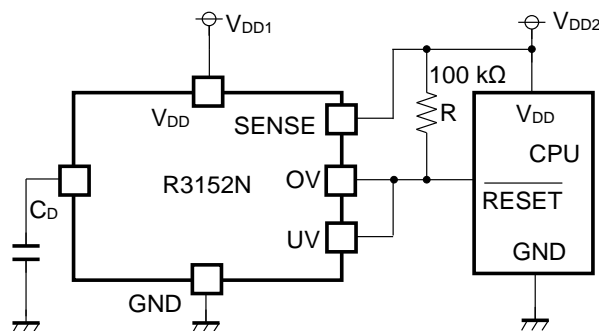

R3152N Typical Application Circuit

## Recommended External Components

Symbol	Description
C <sub>D</sub>	A capacitor corresponding to setting of Release Delay Time is required. Refer to "Delay in Operation and Released Delay Time ( $t_{DELAY}$ )" in Operation Description for details.
R1	A resistor is required to set with consideration of the output current at Nch. driver's ON and the leakage current at Nch. driver's OFF. Refer to "Electrical Characteristic" for details – provided the evaluation result with using a resistor of 100 kΩ.

## TYPICAL CHARACTERISTICS

Typical Characteristics are intended to be used as reference data, they are not guaranteed.

### 1) Load Dump

$V_{UVSET} = 3.0\text{ V}$ ,  $V_{OVSET} = 3.6\text{ V}$ ,  $V_{SENSE} = 3.3\text{ V}$ , Pulled-up to 5.0 V

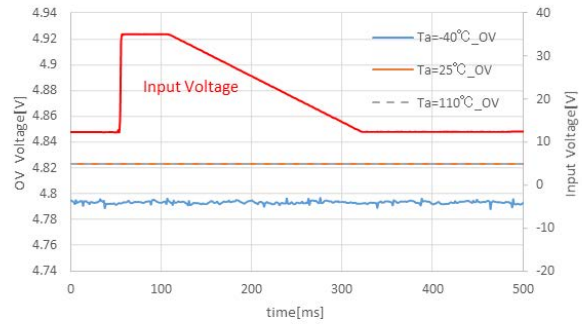
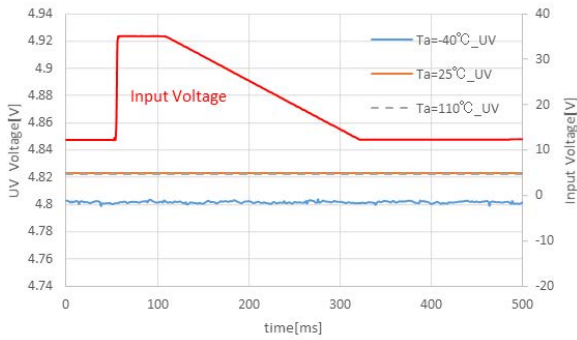

### 2) Cold Crank

$V_{UVSET} = 3.0\text{ V}$ ,  $V_{OVSET} = 3.6\text{ V}$ ,  $V_{SENSE} = 3.3\text{ V}$ , Pulled-up to 5.0 V

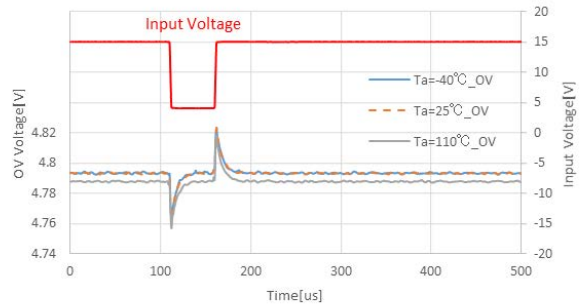
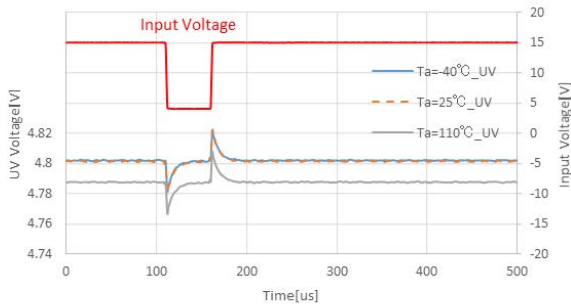

### 3) Supply Current vs. $V_{DD}$

$V_{UVSET} = 1.6\text{ V}$ ,  $V_{OVSET} = 2.0\text{ V}$

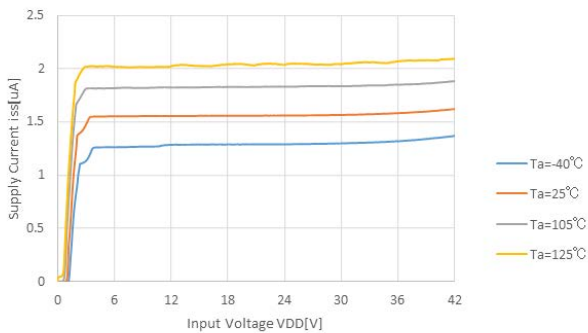

$V_{UVSET} = 3.0\text{ V}$ ,  $V_{OVSET} = 3.6\text{ V}$

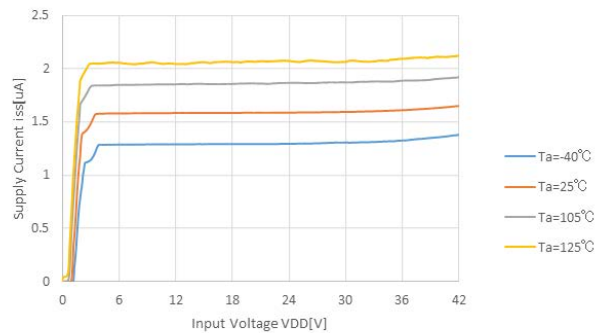

$V_{UVSET} = 4.7\text{ V}$ ,  $V_{OVSET} = 5.3\text{ V}$

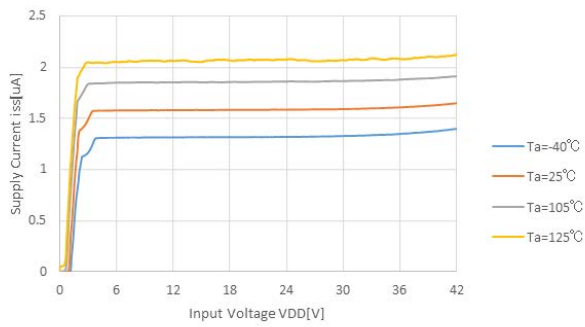

**4) Supply Current vs.  $V_{SENSE}$**

$V_{UVSET} = 1.6\text{ V}$ ,  $V_{OVSET} = 2.0\text{ V}$

$V_{UVSET} = 3.0\text{ V}$ ,  $V_{OVSET} = 3.6\text{ V}$

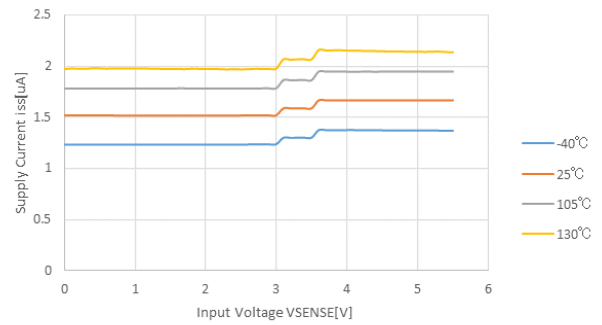
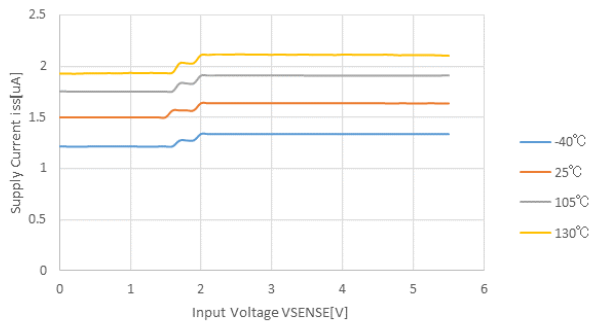

$V_{UVSET} = 4.7\text{ V}$ ,  $V_{OVSET} = 5.3\text{ V}$

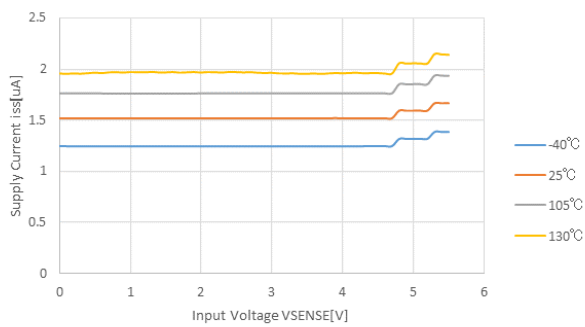

5) UV/OV Detection Voltage vs. Ambient Temperature

$V_{UVSET} = 1.6\text{ V}$ ,  $V_{OVSET} = 2.0\text{ V}$

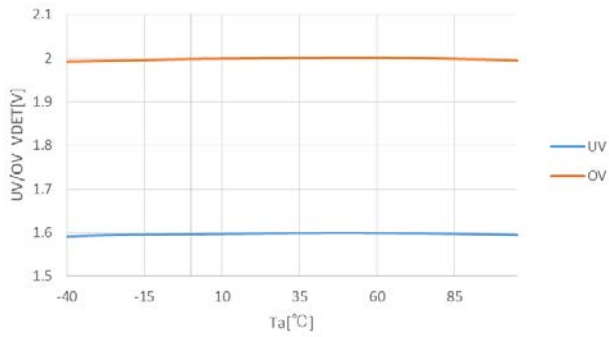

$V_{UVSET} = 3.0\text{ V}$ ,  $V_{OVSET} = 3.6\text{ V}$

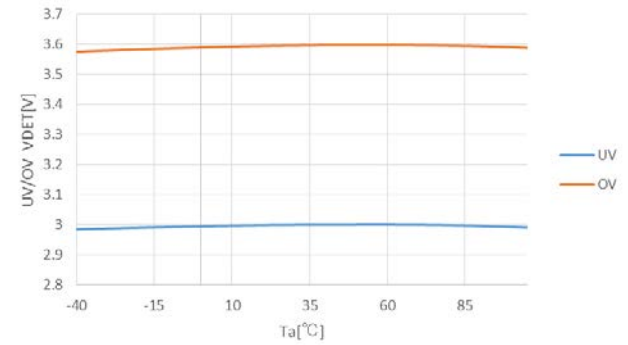

$V_{UVSET} = 4.7\text{ V}$ ,  $V_{OVSET} = 5.3\text{ V}$

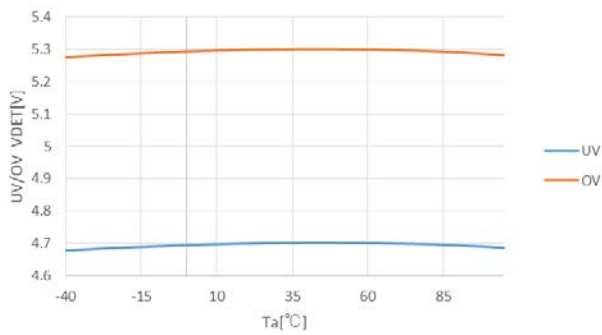

6) UV/OV Release Voltage vs. Ambient Temperature

$V_{UVSET} = 1.6\text{ V}$ ,  $V_{OVSET} = 2.0\text{ V}$

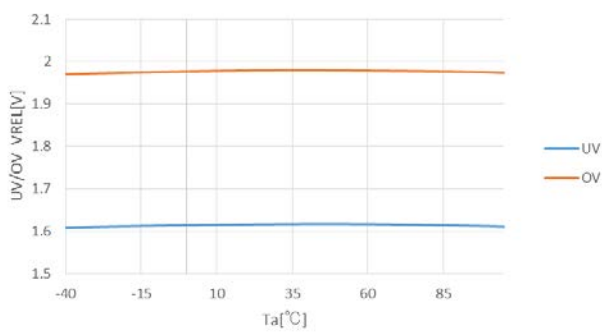

$V_{UVSET} = 3.0\text{ V}$ ,  $V_{OVSET} = 3.6\text{ V}$

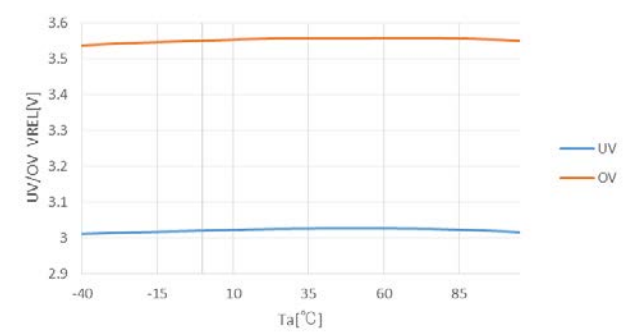

$V_{UVSET} = 4.7\text{ V}$ ,  $V_{OVSET} = 5.3\text{ V}$

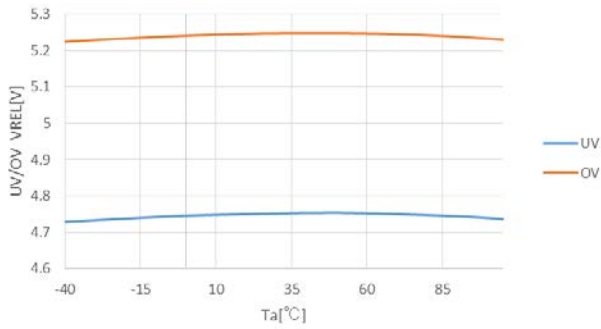

**7) UV/OV Detection Voltage vs. V<sub>DD</sub>**

$V_{UVSET} = 1.6\text{ V}$ ,  $V_{OVSET} = 2.0\text{ V}$

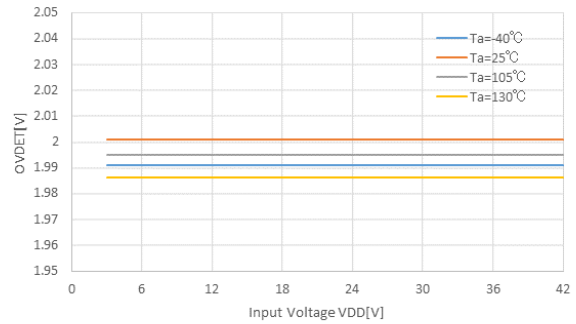
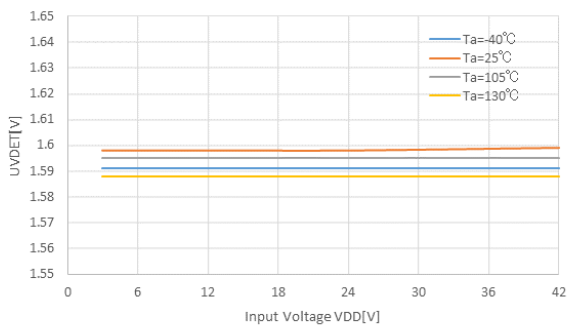

$V_{UVSET} = 3.0\text{ V}$ ,  $V_{OVSET} = 3.6\text{ V}$

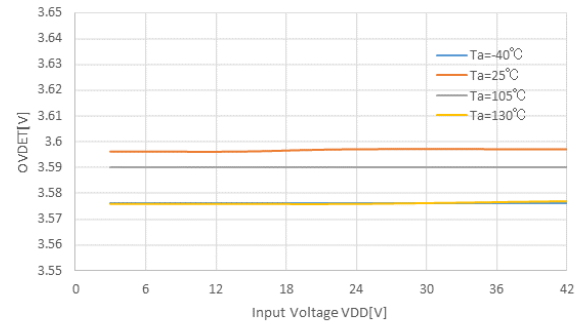
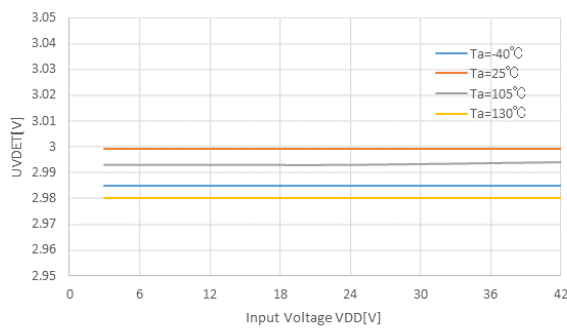

# R3152N

No. EA-405-200904

$V_{UVSET} = 4.7\text{ V}$ ,  $V_{OVSET} = 5.3\text{ V}$

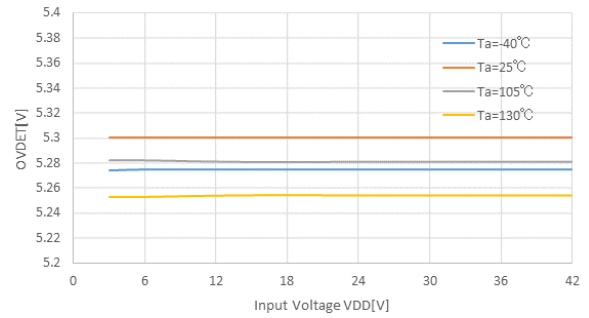
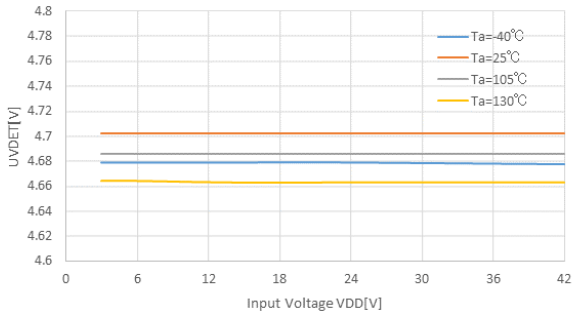

## 8) UV/OV Release Voltage vs. V<sub>DD</sub>

$V_{UVSET} = 1.6\text{ V}$ ,  $V_{OVSET} = 2.0\text{ V}$

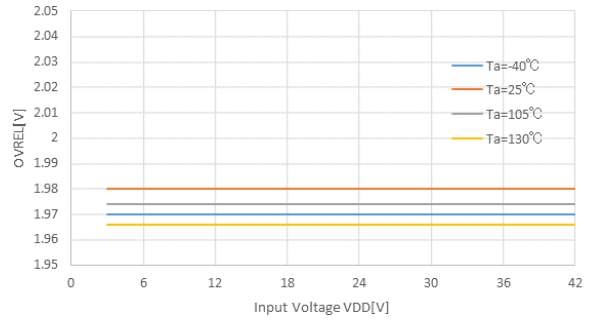
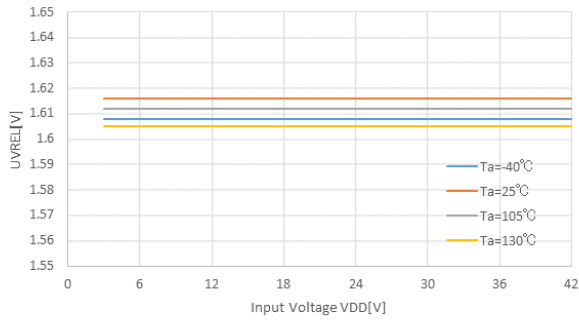

$V_{UVSET} = 3.0\text{ V}$ ,  $V_{OVSET} = 3.6\text{ V}$

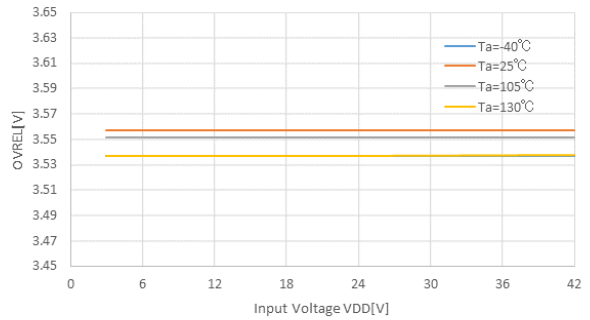
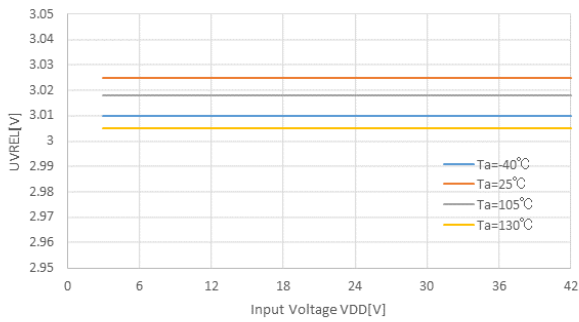



$V_{UVSET} = 4.7\text{ V}$ ,  $V_{OVSET} = 5.3\text{ V}$

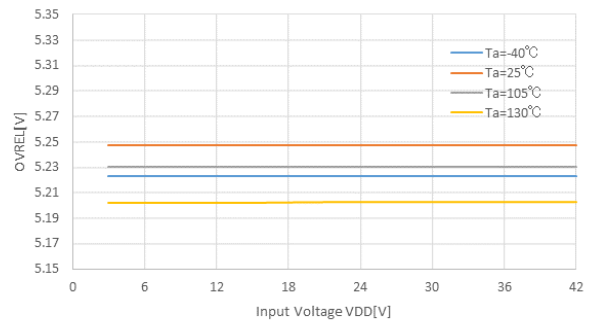
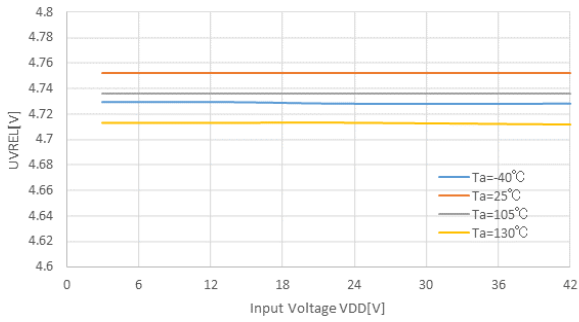

**9) UV/OV Voltage vs.  $V_{DD}$  ( $T_a = 25^\circ\text{C}$ )**

$V_{UVSET} = 1.6\text{ V}$ ,  $V_{OVSET} = 2.0\text{ V}$

$V_{UVSET} = 4.7\text{ V}$ ,  $V_{OVSET} = 5.3\text{ V}$

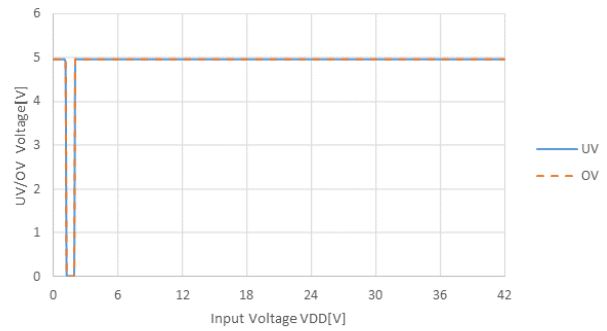
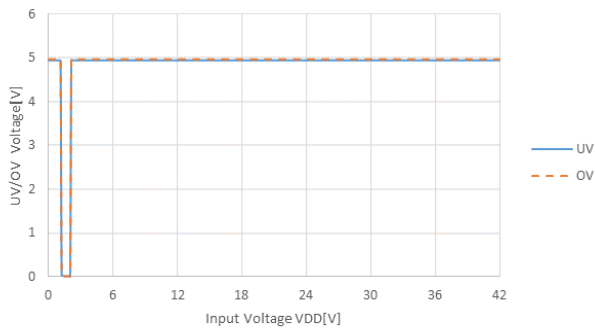

**10) UV/OV Voltage vs.  $V_{SENSE}$  ( $T_a = 25^\circ\text{C}$ )**

$V_{UVSET} = 1.6\text{ V}$ ,  $V_{OVSET} = 2.0\text{ V}$

$V_{UVSET} = 4.7\text{ V}$ ,  $V_{OVSET} = 5.3\text{ V}$

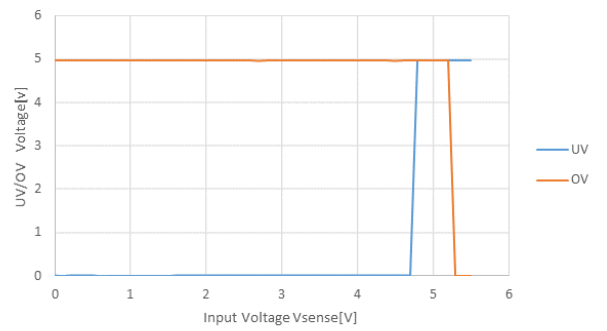
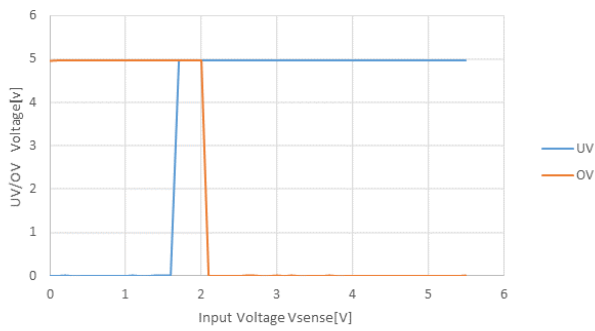

**11) Driver Output Current vs.  $V_{DD}$**

$V_{UVSET} = 4.7\text{ V}$ ,  $V_{OVSET} = 5.3\text{ V}$

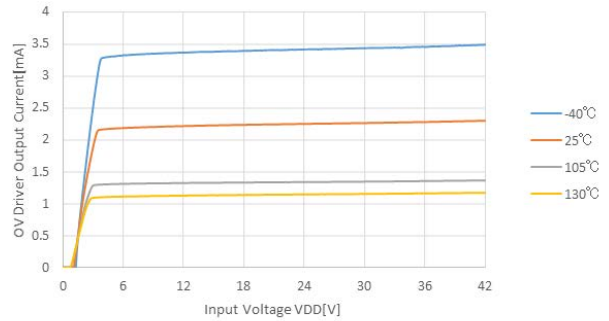
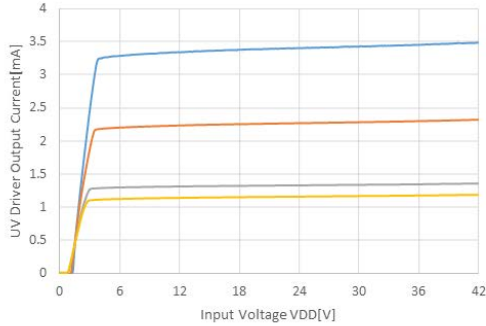

**12) Driver Output Current vs.  $V_{DS}$  ( $T_a = 25^\circ\text{C}$ )**

$V_{UVSET} = 1.6\text{ V}$ ,  $V_{OVSET} = 2.0\text{ V}$

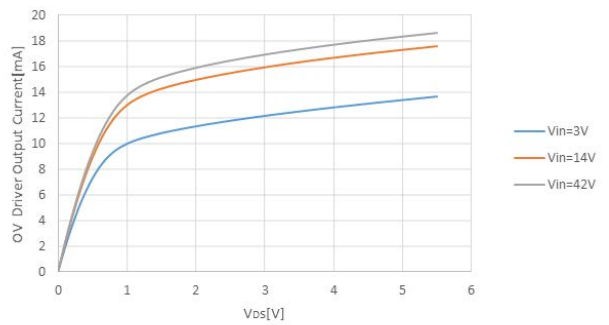
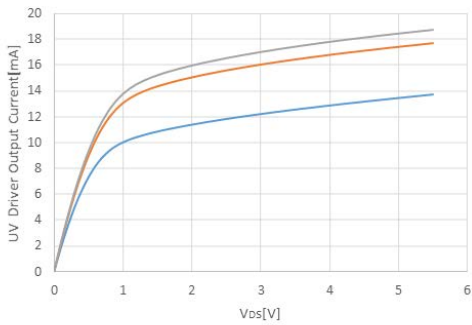

$V_{UVSET} = 4.7\text{ V}$ ,  $V_{OVSET} = 5.3\text{ V}$

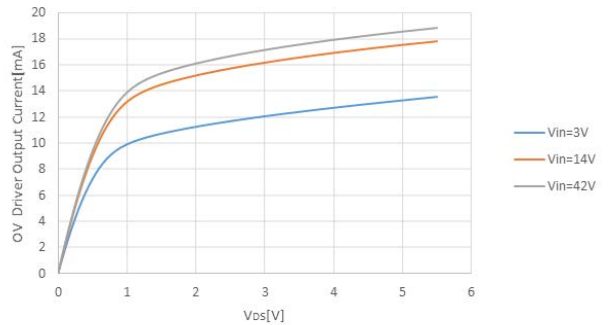
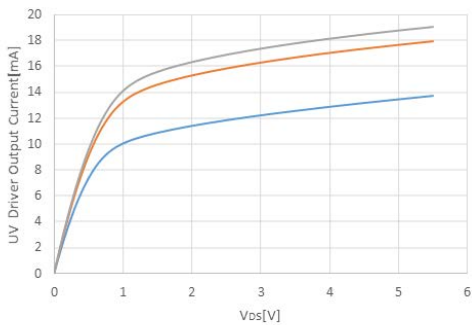

**13) Release Delay Time vs. Ambient Temperature**

$V_{UVSET} = 4.7\text{ V}$ ,  $V_{OVSET} = 5.3\text{ V}$

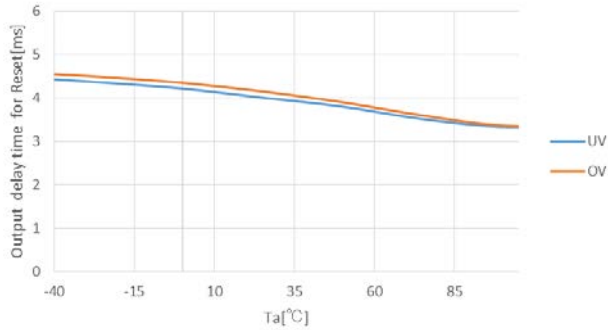

**14) Release Delay Time vs.  $V_{DD}$**

$V_{UVSET} = 4.7\text{ V}$ ,  $V_{OVSET} = 5.3\text{ V}$

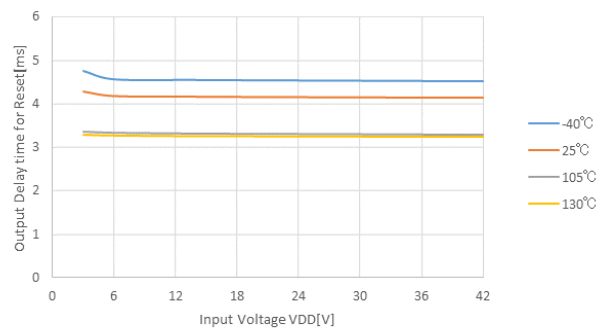
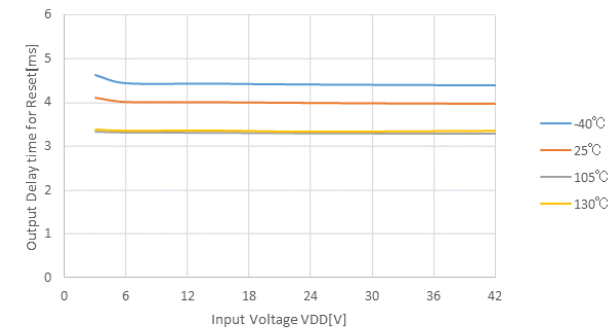

**15) Detection / Release Delay Time vs. External Capacitor for CD Pin**

(Ta = 25°C)

$V_{UVSET} = 4.7\text{ V}$ ,  $V_{OVSET} = 5.3\text{ V}$

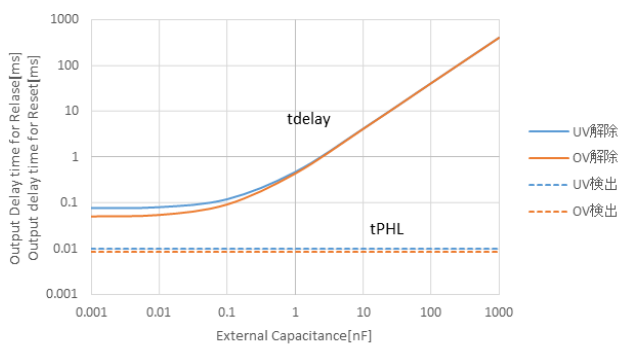

**16) SENSE Pulse Width vs. One Drive Voltage**

(Ta = 25°C)

Release State Threshold Pulse

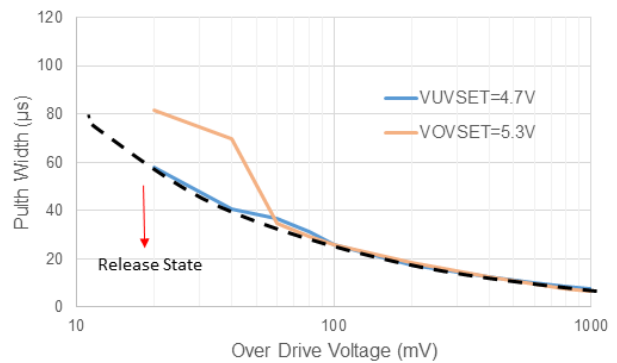

The power dissipation of the package is dependent on PCB material, layout, and environmental conditions. The following measurement conditions are based on JEDEC STD. 51-7.

**Measurement Conditions**

Item	Measurement Conditions
Environment	Mounting on Board (Wind Velocity = 0 m/s)
Board Material	Glass Cloth Epoxy Plastic (Four-Layer Board)
Board Dimensions	76.2 mm × 114.3 mm × 0.8 mm
Copper Ratio	Outer Layer (First Layer): Less than 95% of 50 mm Square Inner Layers (Second and Third Layers): Approx. 100% of 50 mm Square Outer Layer (Fourth Layer): Approx. 100% of 50 mm Square
Through-holes	φ 0.3 mm × 7 pcs

**Measurement Result**

(Ta = 25°C, Tjmax = 125°C)

Item	Measurement Result
Power Dissipation	660 mW
Thermal Resistance (θja)	θja = 150°C/W
Thermal Characterization Parameter (ψjt)	ψjt = 51°C/W

θja: Junction-to-Ambient Thermal Resistance

ψjt: Junction-to-Top Thermal Characterization Parameter

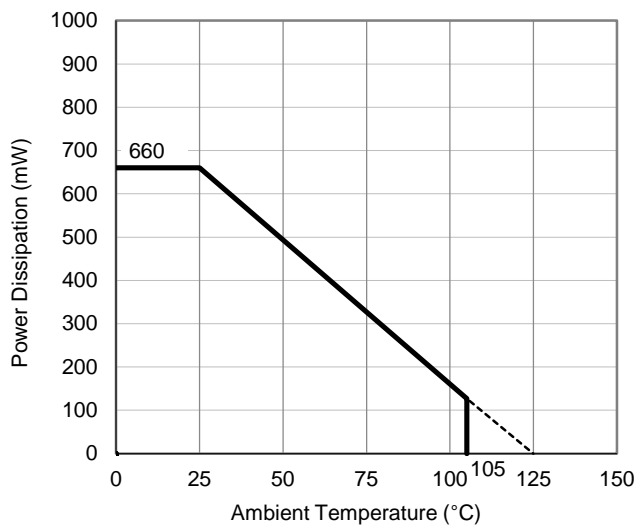

**Power Dissipation vs. Ambient Temperature**

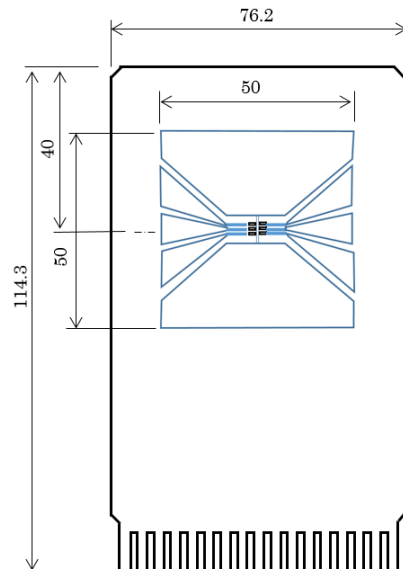

**Measurement Board Pattern**

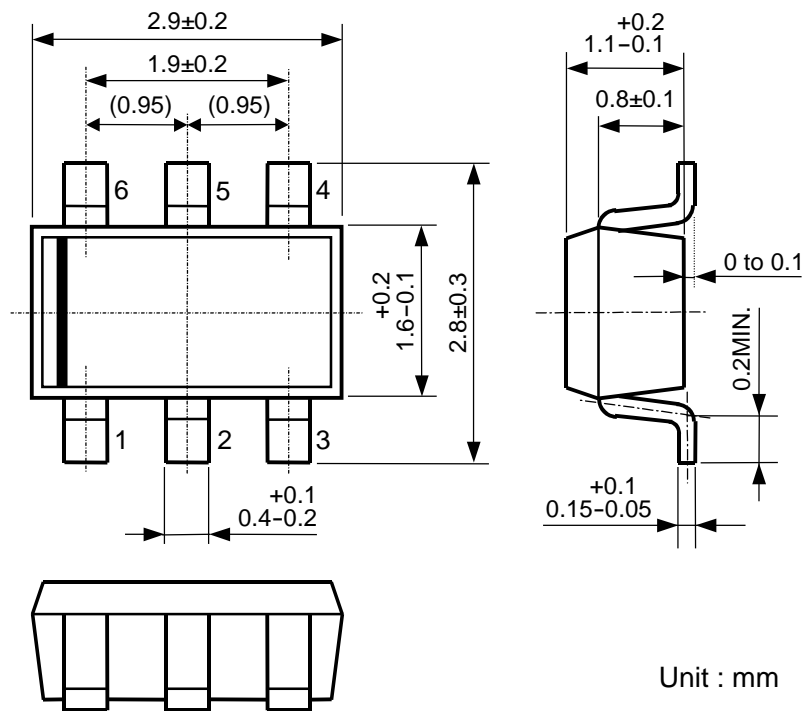

Unit : mm

SOT-23-6 Package Dimensions



1. The products and the product specifications described in this document are subject to change or discontinuation of production without notice for reasons such as improvement. Therefore, before deciding to use the products, please refer to Ricoh sales representatives for the latest information thereon.
2. The materials in this document may not be copied or otherwise reproduced in whole or in part without prior written consent of Ricoh.
3. Please be sure to take any necessary formalities under relevant laws or regulations before exporting or otherwise taking out of your country the products or the technical information described herein.
4. The technical information described in this document shows typical characteristics of and example application circuits for the products. The release of such information is not to be construed as a warranty of or a grant of license under Ricoh's or any third party's intellectual property rights or any other rights.
5. The products listed in this document are intended and designed for use as general electronic components in standard applications (office equipment, telecommunication equipment, measuring instruments, consumer electronic products, amusement equipment etc.). Those customers intending to use a product in an application requiring extreme quality and reliability, for example, in a highly specific application where the failure or misoperation of the product could result in human injury or death (aircraft, spacevehicle, nuclear reactor control system, traffic control system, automotive and transportation equipment, combustion equipment, safety devices, life support system etc.) should first contact us.
6. We are making our continuous effort to improve the quality and reliability of our products, but semiconductor products are likely to fail with certain probability. In order to prevent any injury to persons or damages to property resulting from such failure, customers should be careful enough to incorporate safety measures in their design, such as redundancy feature, fire containment feature and fail-safe feature. We do not assume any liability or responsibility for any loss or damage arising from misuse or inappropriate use of the products.
7. Anti-radiation design is not implemented in the products described in this document.
8. The X-ray exposure can influence functions and characteristics of the products. Confirm the product functions and characteristics in the evaluation stage.
9. WLCSP products should be used in light shielded environments. The light exposure can influence functions and characteristics of the products under operation or storage.
10. There can be variation in the marking when different AOI (Automated Optical Inspection) equipment is used. In the case of recognizing the marking characteristic with AOI, please contact Ricoh sales or our distributor before attempting to use AOI.
11. Please contact Ricoh sales representatives should you have any questions or comments concerning the products or the technical information.



**Ricoh is committed to reducing the environmental loading materials in electrical devices with a view to contributing to the protection of human health and the environment.**

Ricoh has been providing RoHS compliant products since April 1, 2006 and Halogen-free products since April 1, 2012.

**RICOH** RICOH ELECTRONIC DEVICES CO., LTD.

**Official website**

<https://www.n-redc.co.jp/en/>

**Contact us**

<https://www.n-redc.co.jp/en/buy/>

