

Features

- 30V/7A,
 $R_{DS(ON)} = 18m\Omega(Typ.)@V_{GS}=10V$
 $R_{DS(ON)} = 22m\Omega(Typ.)@V_{GS}=4.5V$
 $R_{DS(ON)} = 30m\Omega(Typ.)@V_{GS}=2.5V$
- Low $R_{DS(ON)}$
- Super High Dense Cell Design
- Reliable and Rugged

Applications

- Power Management
- Battery Protection



Halogen-Free

Pin Description

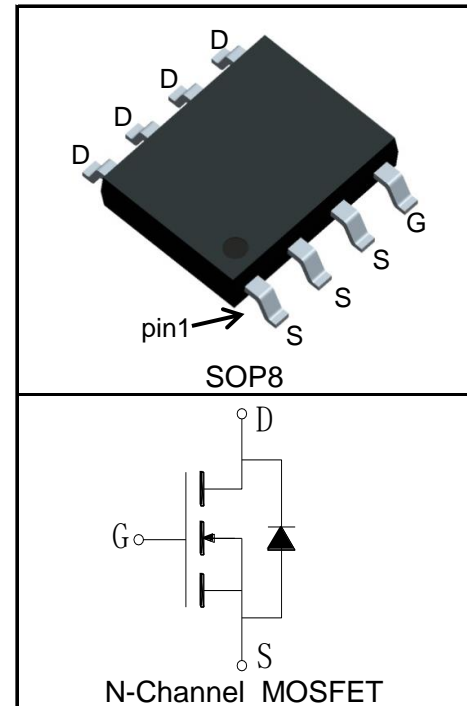

Absolute Maximum Ratings

Symbol	Parameter	Rating	Unit	
Common Ratings ($T_A=25^\circ\text{C}$ Unless Otherwise Noted)				
V_{DSS}	Drain-Source Voltage	30	V	
V_{GSS}	Gate-Source Voltage	± 12		
T_J	Maximum Junction Temperature	150	$^\circ\text{C}$	
T_{STG}	Storage Temperature Range	-55 to 150	$^\circ\text{C}$	
I_S	Diode Continuous Forward Current	$T_A=25^\circ\text{C}$	2.9	A
Mounted on Large Heat Sink				
$I_{DP}^{①}$	300 μs Pulse Drain Current Tested	$T_A=25^\circ\text{C}$	28	A
$I_D^{②}$	Continuous Drain Current($V_{GS}=10V$)	$T_A=25^\circ\text{C}$	7	A
		$T_A=70^\circ\text{C}$	5.6	
P_D	Maximum Power Dissipation	$T_A=25^\circ\text{C}$	2.5	W
		$T_A=70^\circ\text{C}$	1.6	
$R_{\theta JC}$	Thermal Resistance-Junction to Case	-	$^\circ\text{C/W}$	
$R_{\theta JA}^{③}$	Thermal Resistance-Junction to Ambient	50	$^\circ\text{C/W}$	
Drain-Source Avalanche Ratings				
$E_{AS}^{④}$	Avalanche Energy, Single Pulsed	TBD	mJ	

Electrical Characteristics ($T_A=25^\circ\text{C}$ Unless Otherwise Noted)

Symbol	Parameter	Test Condition	KS3244HC			Unit
			Min.	Typ.	Max.	
Static Characteristics						
BV_{DSS}	Drain-Source Breakdown Voltage	$V_{GS}=0V, I_{DS}=250\mu A$	30			V
I_{DSS}	Zero Gate Voltage Drain Current	$V_{DS}=30V, V_{GS}=0V$			1	μA
		$T_J=125^\circ\text{C}$			30	
$V_{GS(th)}$	Gate Threshold Voltage	$V_{DS}=V_{GS}, I_{DS}=250\mu A$	0.6	0.9	1.2	V
I_{GSS}	Gate Leakage Current	$V_{GS}=\pm 12V, V_{DS}=0V$			± 100	nA
$R_{DS(ON)}^{(5)}$	Drain-Source On-state Resistance	$V_{GS}=10V, I_{DS}=4A$		18	26	$m\Omega$
		$V_{GS}=4.5V, I_{DS}=3A$		22	32	$m\Omega$
		$V_{GS}=2.5V, I_{DS}=2A$		30	50	$m\Omega$
Diode Characteristics						
$V_{SD}^{(5)}$	Diode Forward Voltage	$I_{SD}=4A, V_{GS}=0V$		0.84	1.2	V
t_{rr}	Reverse Recovery Time	$I_{SD}=4A, di_{SD}/dt=100A/\mu s$		8		ns
Q_{rr}	Reverse Recovery Charge			15		nC
Dynamic Characteristics⁽⁶⁾						
R_G	Gate Resistance	$V_{GS}=0V, V_{DS}=0V, F=1\text{MHz}$		0.9		Ω
C_{iss}	Input Capacitance	$V_{GS}=0V,$ $V_{DS}=15V,$ Frequency=1.0MHz		530		pF
C_{oss}	Output Capacitance			125		
C_{riss}	Reverse Transfer Capacitance			35		
$t_{d(ON)}$	Turn-on Delay Time	$V_{DD}=15V, I_{DS}=4A,$ $V_{GEN}=10V, R_G=6\Omega$		10		ns
t_r	Turn-on Rise Time			17		
$t_{d(OFF)}$	Turn-off Delay Time			22		
t_f	Turn-off Fall Time			8		
Gate Charge Characteristics⁽⁶⁾						
Q_g	Total Gate Charge	$V_{DS}=15V, V_{GS}=10V,$ $I_{DS}=4A$		8.2		nC
Q_{gs}	Gate-Source Charge			1.3		
Q_{gd}	Gate-Drain Charge			2.1		

- Notes:
- ① Pulse width limited by safe operating area.
 - ② Calculated continuous current based on maximum allowable junction temperature.
 - ③ When mounted on 1 inch square copper board, $t \leq 10\text{sec}$. The value in any given application depends on the user's specific board design.
 - ④ Limited by T_{Jmax} , starting $T_J = 25^\circ\text{C}$.
 - ⑤ Pulse test; Pulse width $\leq 300\mu s$, duty cycle $\leq 2\%$.
 - ⑥ Guaranteed by design, not subject to production testing.

Ordering and Marking Information

Device	Package	Packaging	Quantity	Reel Size	Tape width
KS3244HC	SOP8	Tape&Reel	3000	13"	12mm

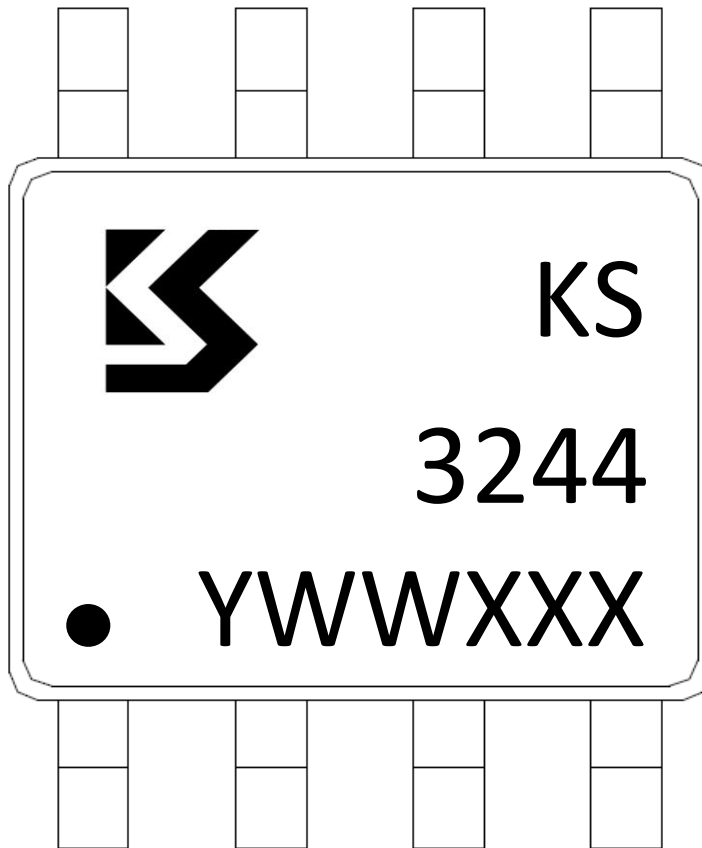

Y =Year,2017-A,2018-B,etc.

WW =Week.

XXX =Lot number.

Typical Characteristics

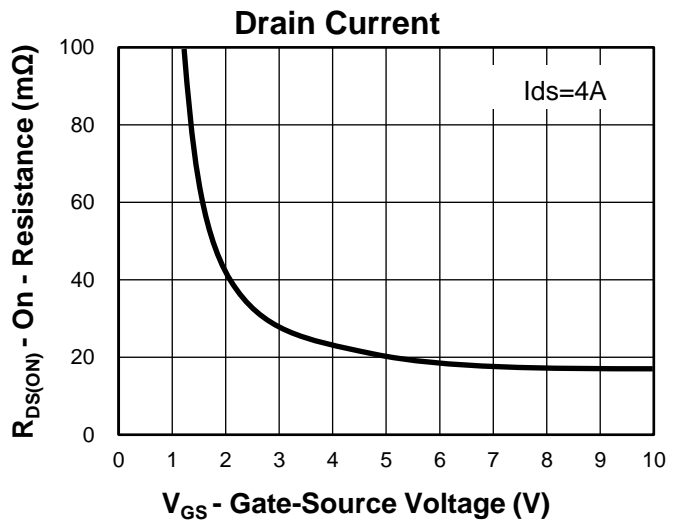
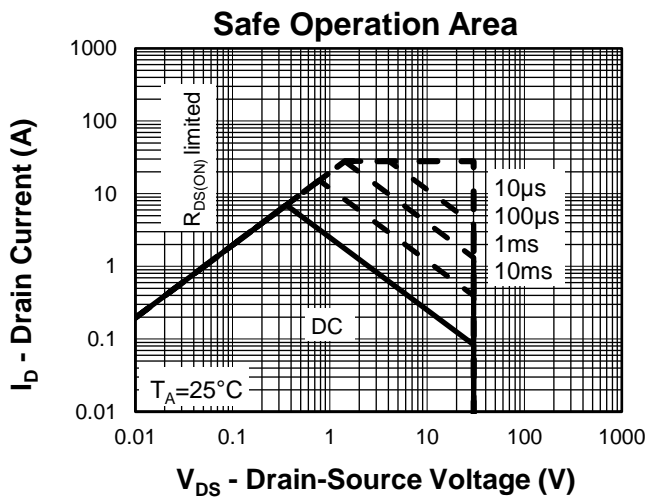
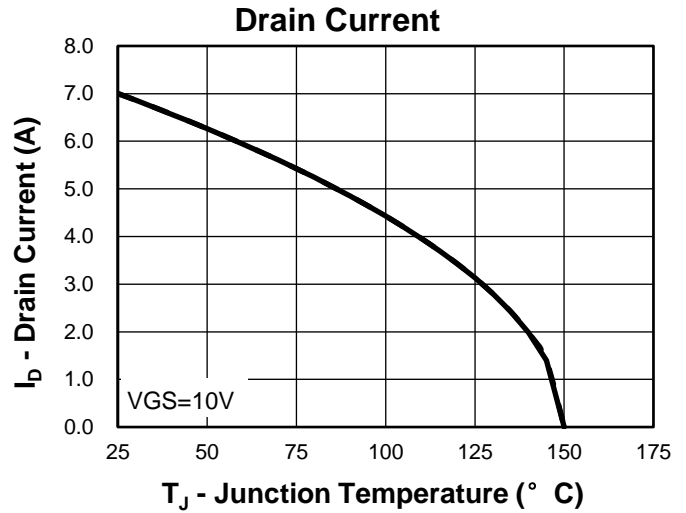
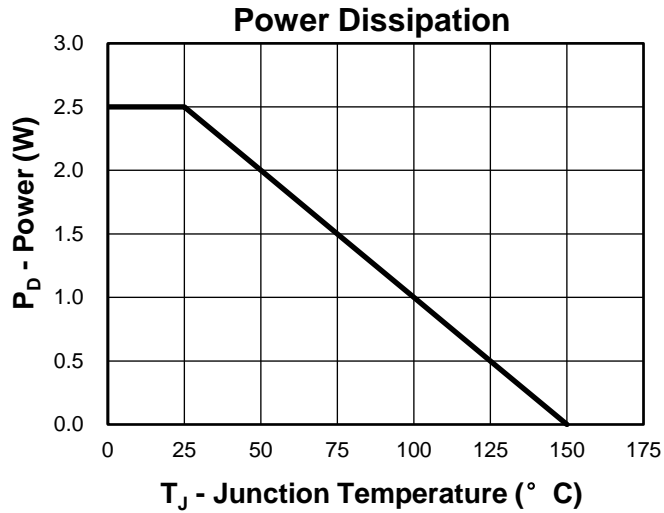

Thermal Transient Impedance

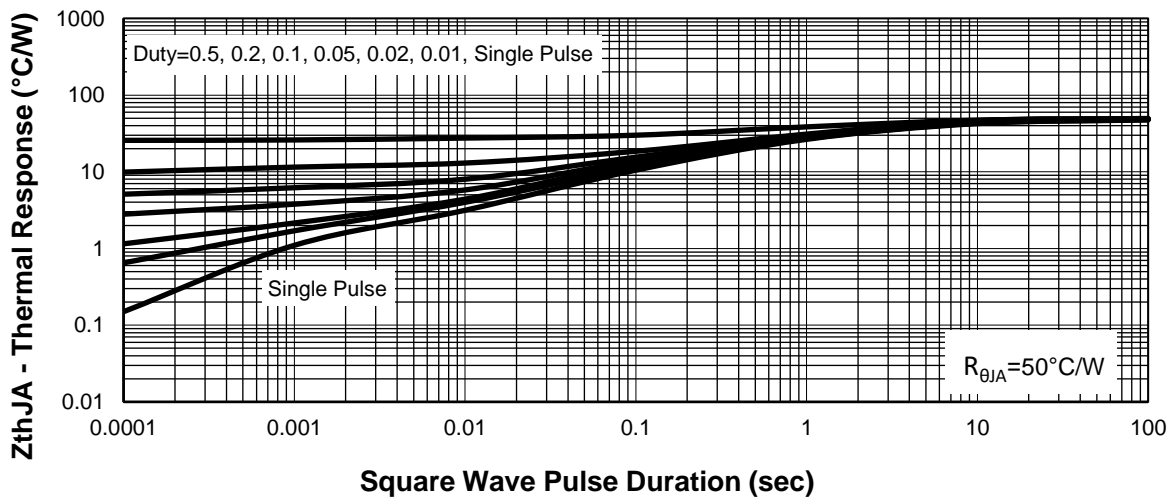

Typical Characteristics

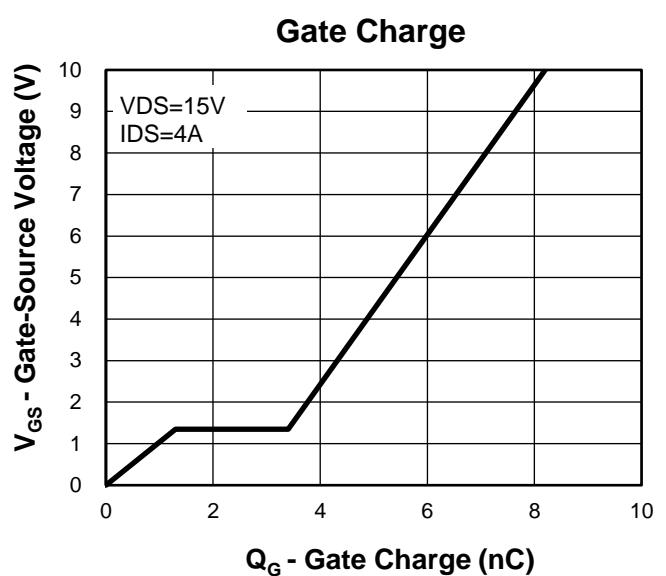
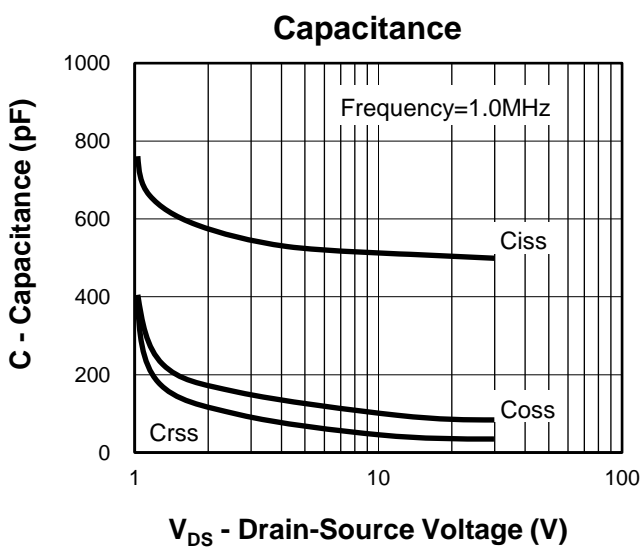
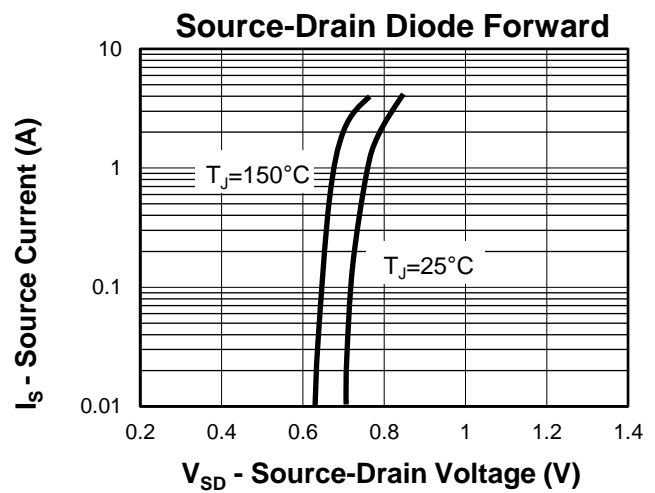
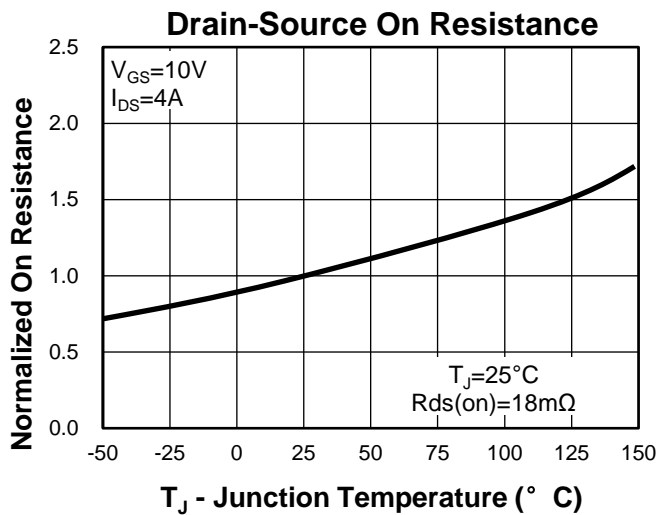
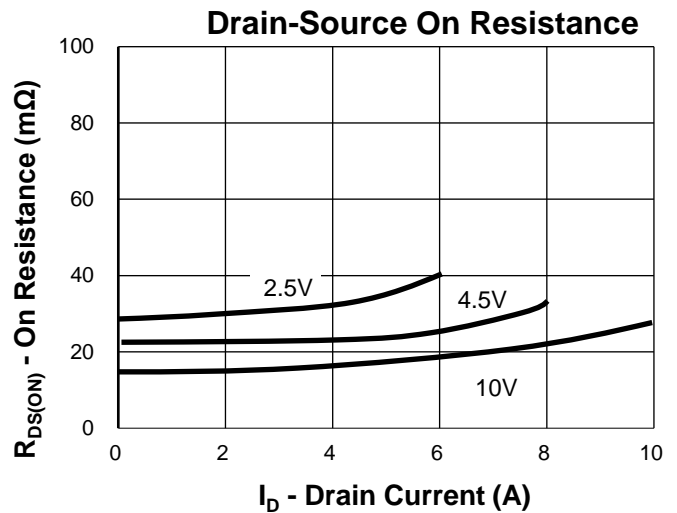
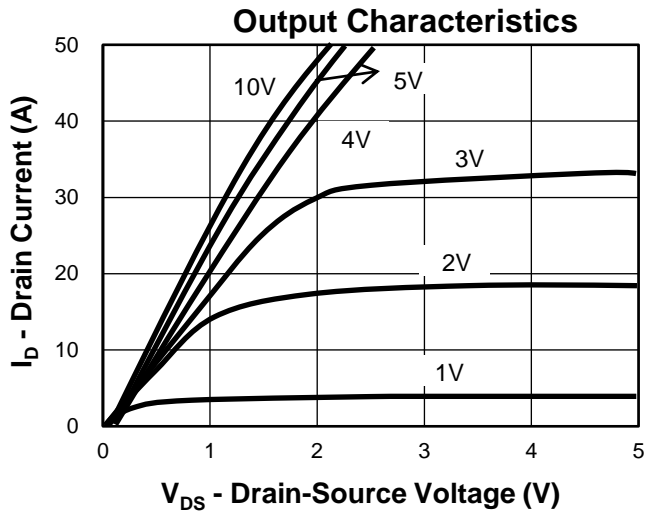

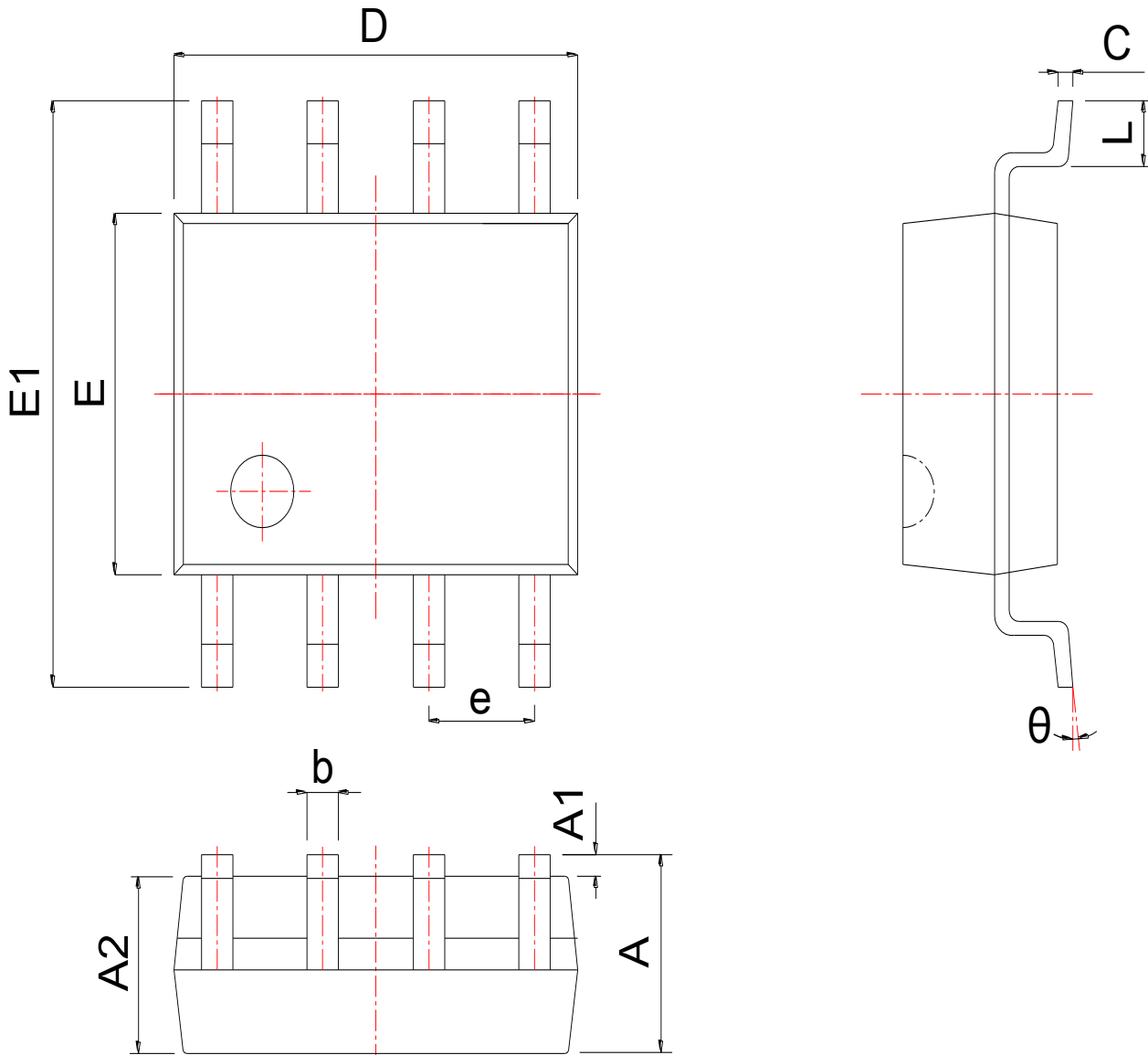
Package Information
SOP8

SYMBOL	MM			INCH		
	MIN	NOM	MAX	MIN	NOM	MAX
A	1.300	1.525	1.750	0.051	0.060	0.069
A1	0.050	0.150	0.250	0.002	0.006	0.010
A2	1.350	1.450	1.550	0.053	0.057	0.061
b	0.330	0.420	0.510	0.013	0.017	0.020
c	0.170	0.210	0.250	0.007	0.008	0.010
D	4.700	4.900	5.100	0.185	0.193	0.201
E	3.800	3.900	4.000	0.150	0.154	0.157
E1	5.800	6.000	6.200	0.228	0.236	0.244
e	1.270 BSC			0.050 BSC		
L	0.400	0.835	1.270	0.016	0.033	0.050
θ	0°		8°	0°		8°

Avalanche Test Circuit and Waveforms



Switching Time Test Circuit and Waveforms



Diode Recovery Test Circuit and Waveforms



Gate Charge Test Circuit and Waveform



DISCLAIMER:

Kwansemi reserves the right to change the specifications and circuitry without notice at any time. The Products are not designed for use in hostile environments, including, without limitation, aircraft, nuclear power generation, medical appliances, and devices or systems in which malfunction of any Product can reasonably be expected to result in a personal injury. Seller's customers using or selling Seller's products for use in such applications do so at their own risk and agree to fully defend and indemnify Seller.

联系我们

深圳市泰德兰电子有限公司（简称：泰德兰），是一家专业代理国内外品牌电子元器件代理商。“泰德兰”的目标是为客户提供高性价比的产品和服务。我们一贯坚持：“品质第一、价格合理、交货快捷、服务至上、凝聚客户”的发展理念和宗旨以向采购商提供最满意的服务为己任，向采购商提供规范化、专业化、多元化、全方位的优质服务，真诚欢迎海内外直接用户前来洽谈合作，共谋发展！也希望能与电子界同行进行广泛的交流合作共同为行业的繁荣发展做出贡献！

目前，泰德兰电子主要代理：霍尼韦尔、理光、NJRC、英集芯、维安、贝岭、捷捷微、冠禹、松木、辉芒微、茂捷和元拓等。

主营产品线有 LDO、DC/DC、AC-DC、电压检测器、充电 IC、负载开关 IC、保险丝、多功能集成保护 IC、功率 TVS 管、二三极管、PMU、马达驱动、LED 驱动、功率器件、数字电源、Hall IC、磁组、传感器 IC、汽容胶传感器、压力传感器、位移传感器、惯导模块、锂电保护芯片、微动开关、PTC、ESD、EEPROM, 8bit/32bit MCU, PMIC、中低压 MOS 管、高压 COOL MOS、高压平面 MOSFET 等。

“泰德兰”代理的产品被广泛应用于液晶电视、笔记本、联网、便携式设备、机顶盒、闭路电视/安全、桌面、LED 照明、玩具、网络电视机、无人机、扫地机、无线充、蓝牙设备、汽车应用、行车记录仪、无线路由等领域。

“泰德兰”所代理的产品均通过 ISO 9001:2000 品质管理系统检验；获得原厂颁发的代理授权证书。

深圳公司

深圳市泰德兰电子有限公司

地址：深圳市福田区彩田南路 2010 号中深花园 A 座六层

电话：0755-83322522 传真：0755-83648400

手机：131-89714166 Q Q：2853781768

香港公司

香港富研科技有限公司

地址：香港葵涌青山公路葵涌段 313 号天际中心 15 楼 1506 室

电话：852-23113966 邮箱：ll@icbest.com

苏州公司

苏州市泰美兰电子有限公司

地址：苏州姑苏区总官堂路 555 号苏尚新地生活广场 1 幢 802 室

电话：0512-67665578 邮箱：wg@icbest.com